

Method of Splitting Tsunami (MOST) Software Manual

7/6/2006

The National Oceanic & Atmospheric Administration
Pacific Marine Environmental Laboratory
Tsunami Research Program

Written in association with

the
writestuff
Content Creation & Presentation



Abstract

This manual describes how to use the **Method of Splitting Tsunami** (MOST) numerical simulation model developed by the [Pacific Marine Environmental Laboratory](#) (PMEL) of the [National Oceanic and Atmospheric Administration](#) (NOAA), the lead agency for providing tsunami forecasts and warnings to the United States.

The MOST simulation is designed to provide researchers an effective means for studying tsunami behavior and making long-term predictions, and to support the work of the [Tsunami Warning Centers](#), the [Pacific Disaster Center](#), and other emergency managers in forecasting the effect that a potentially tsunami-generating seismic event may have on coastal regions.



Disclaimers

For a disclaimer contact:

Nancy Soreide

NOAA/Pacific Marine Environmental Laboratory

7600 Sand Point Way NE, Seattle, WA 98115

Phone: 206-526-6728 | Fax: 206-526-4576

Email: Nancy.N.Soreide@noaa.gov



Contents

Abstract	iii
Disclaimers	iv
Illustrations	viii
Tables	ix
Getting Started	10
Introduction	10
Recommended Linux Environment	10
Requesting MOST Software	11
List of MOST Program files	11
User Guide	13
MOST Data Inputs	13
MOST Digital Elevation Models	13
DEM Data Requirements	13
Constructing DEM Data Sets	15
Seismic Inputs	18
Using Multiple Deformation Rectangles	20
Obtaining Fault Information	21
Input Correction Tools	21
bath_sample	22
bath_corr	23
Performing Tsunami Modeling Using MOST	26
Deformation Phase Modeling	26
Deformation Phase Input Data	26
Running deform	27
Deformation Phase Outputs	29
Troubleshooting Deformation Phase Simulations	29
Propagation Phase Modeling	30
Propagation Phase Input Data	30
Running propagation	31
Propagation Phase Outputs	37
Inundation Phase Modeling	37



MOST Software Manual

Inundation Phase Input Data.....	38
Running inundation	39
Inundation Phase Outputs.....	47
Reference Guide	49
Executables.....	49
deform.....	49
propagation.....	55
propagation Command Inputs	55
propagation Command Outputs.....	58
propagation Data Inputs	60
propagation Data Outputs.....	60
inundation.....	61
inundation Restrictions	61
inundation Command Inputs	61
inundation Command Outputs.....	70
inundation Data Inputs	72
inundation Data Outputs.....	74
bath_sample	76
bath_sample Restrictions	76
bath_sample Command Inputs.....	76
bath_sample Command Outputs	78
bath_sample Data Inputs.....	79
bath_sample Data Outputs	79
bath_corr	79
bath_corr Restrictions.....	80
bath_corr Command Input.....	80
bath_corr Command Outputs	81
bath_corr Data Inputs	82
bath_corr Data Outputs.....	82
Data File Formats.....	83
DEM Data File Format.....	83
Deformation Output File Format	85



Wave Evolution File Formats.....	86
Wave Height File Format.....	86
Meridional Velocity File Format.....	88
Zonal Velocity File Format.....	90
Appendix I: Performance Issues.....	93
Propagation Phase Performance.....	93
Inundation Phase Performance.....	93
Appendix II: Troubleshooting.....	94
Deformation Phase Simulations.....	94
Troubleshooting Bathymetric Smoothing.....	94
Troubleshooting Tsunami Wave Evolution Programs.....	95
Appendix III: Acronyms.....	96
Appendix XIV: Glossary.....	97
Appendix V: Units.....	101
Appendix VI: Numerical Methods.....	102
Most Numerical Model Background.....	102
Courant, Friedrichs, and Lewy (CFL) Stability Condition.....	102
Appendix VII: Data Resources.....	103
Seismic Information Data Resources.....	103
Digital Elevation Model Data Resources.....	103
Appendix VIII: Recommended Software.....	104
Visualization and Data Management Software.....	104
GIS Software.....	104
References.....	105
Index.....	106



Illustrations

Figure 2: Grid Mismatch—The Difference in Vertical Coordinates Between Two Nested Grids 17

Figure 3: Matching Nested Grids 18

Figure 4: Earthquake Fault Parameters and Geometry System 19

Figure 5: Deformation Rectangle 20

Figure 6: Fault Decomposed to Reformation Rectangles 21

Figure 7: Projection of Deformation Rectangle to Deformation Phase Output Area 29

Figure 8: DEM and Tsunami Propagation 32

Figure 9: Propagation Phase and Inundation Phase Data Grids 34

Figure 10: Inundation Phase Nested Grids 40



Tables

Table 1 System Recommendations.....	10
Table 2 Minimum Grid Requirements for Each Phase.....	13
Table 3 MOST Digital Elevation Model Grids Data Requirements.....	14
Table 4 MOST Digital Elevation Model Grids Spatial Resolution.....	14
Table 5 Recommended MOST Data Parameters.....	15
Table 6 Some Recommended Sources of DEM Data.....	16



Getting Started

This section provides introductory information about the Method of Splitting Tsunami (MOST) numerical simulation tool, as well as information about how to obtain and install MOST.

Introduction

MOST is a tsunami modeling tool that can be obtained from the Pacific Marine Environmental Laboratory (PMEL) of the National Oceanic and Atmospheric Administration (NOAA); web site: <http://pmel.noaa.gov/>. The MOST installation consists of source, executable, sample, and data files and is designed to run on high-end, Intel™-based Linux®/UNIX® systems. The MOST tool set includes verification examples to help confirm that MOST was installed successfully, and supporting tools to assist in selecting and modifying bathymetric data.

Tsunami modeling using MOST proceeds in three distinct stages:

- A [Deformation Phase](#) generates the initial conditions for a tsunami by simulating ocean floor changes due to a seismic event.
- A [Propagation Phase](#) propagates the generated tsunami across deep ocean using Nonlinear Shallow Water (NSW) wave equations.
- An [Inundation Phase](#) simulates the shallow ocean behavior of a tsunami by extending the NSW calculations using a multi-grid “run-up” algorithm to predict coastal flooding and inundation.

MOST simulations using all three phases require the following sets of input data:

- The amount and distribution of the sea-floor dislocation, induced by a seismic event.
- Gridded bathymetric data information for the open ocean propagation.
- A set of gridded [Digital Elevation Models](#) (DEM) containing bathymetry and topography for use during the inundation phase. The set consists of one DEM that contains bathymetric and topographical information, and two DEMs that contain bathymetrical information and optional topographical information.

Some sample input data sets are provided with the MOST package. In general, however, the tsunami modeler must obtain the necessary seismic and bathymetric information for any particular simulation run.

Recommended Linux Environment

The following Linux system configuration is recommended for use with MOST:

Table 1 System Recommendations

Requirement	Configuration
Operating system	Red Hat Enterprise Linux v 4.2
Processor type	At least Intel Xeon or equivalent
Processor cache	2 MB
Processor speed	2.6 GHz



Processor memory	5 GB
Disk space allocated for MOST	2 GB
Supporting software	netCDF V 3.6.1 or greater
Fortran compiler (Portland Group)	Release 6.1
Fortran compiler (GNU)	3.2.3

Requesting MOST Software

To submit a formal request for MOST software, send your request to:

Nancy Soreide

NOAA/Pacific Marine Environmental Laboratory

7600 Sand Point Way NE, Seattle, WA 98115

Phone: 206-526-6728 | Fax: 206-526-4576

Email: Nancy.N.Soreide@noaa.gov

List of MOST Program files

You can obtain MOST software from its authoring agency, PMEL. The MOST installation kit should include the following files:

- most3_facts_nc.f
- bath_read.f
- indx.f
- indx_off.f
- remove_islands.f
- source_read.f
- source_readDB.f
- deform_read.f
- surf_write.f
- max_write.f
- comp_max.f
- rgrd1.f
- rgrd2.f



MOST Software Manual

- timestep.f
- timestep_n.f
- swlat_n.f
- swlon_n.f
- swrun.f
- bounds.f
- timestep_nr.f
- swrun_lon.f
- swrun_lat.f
- bounds_nr.f
- check_err.f
- freadNC.f
- read_recs.f
- write_recs.f
- max_value.f
- Makefile
- bath_corr.f
- bath_sample.f



User Guide

This section describes how to run tsunami simulations using [MOST](#), including descriptions of:

- Required data input and construction procedures.
- The **deform**, **propagation**, and **inundation** executables that are used to process the three phases of a MOST simulation: the Deformation Phase, the Propagation Phase, and the Inundation Phase.
- The MOST bathymetric selection and smoothing tools **bath_sample** and **bath_corr**.

MOST Data Inputs

A tsunami simulation requires two distinct types of input:

- Seismic data that contains information about a major dislocation to the ocean floor due to a rupture along a [fault line](#).
- A [DEM](#) that describes the [bathymetry](#) and [topography](#) on a structured geographic (x,y) grid system of the undersea and onshore environment used in modeling tsunami propagation.

For a full MOST simulation, four distinct sets of DEM are required:

- One bathymetric data set for open-ocean tsunami modeling.
- A group of three nested DEM inputs used to calculate tsunami onshore run-up or inundation.

MOST Digital Elevation Models

A full MOST simulation for tsunami behavior—from seismic input to onshore inundation—requires the appropriate selection of four DEM input data sets. DEM data sets specify ocean depths or dry land elevations within a well-defined x,y coordinate system, which is mapped to a finite difference grid used as input to MOST calculations.

Note that the MOST model defines positive grid values as "water" and negative grid values as "land." This convention is the opposite of that defined by the geospatial community. Be careful when using packaged DEMs, as they are usually based on the standard geospatial convention that encodes negative values as water.

DEM Data Requirements

The following table shows the required number of input DEM grids that are required for each MOST phase.

Table 2 Minimum Grid Requirements for Each Phase

MOST Simulation Phase	Grids
Deformation/ Propagation	1
Inundation	3



Even though Deformation and Propagation phases may be distinct, a single grid is used for both phases. The Inundation Phase requires that the Deformation and Propagation phases to be completed first.

The three DEM grids used by the Inundation Phase are a nested set of DEM bathy/topo data with increasing resolution. The inner resolution data set, referred to as Grid C, has the smallest coverage but defines the target or area of principal interest in an inundation study. The outer, coarsest data set, Grid A, covers the largest area used in the Inundation Phase calculation and defines the Propagation Phase boundary. The intermediate data set, Grid B, provides a transition region to improve the accuracy of MOST inundation calculations.

Table 3 MOST Digital Elevation Model Grids Data Requirements

MOST Simulation Phase	Detailed Bathymetry	Detailed Topography
Deformation	Required	Not Required
Propagation	Required	Not Required
Inundation:		
Grid A (Outer)	Required	Optional unless run-up enabled
Grid B (Intermediate)	Required	Optional unless run-up enabled
Grid C (Inner)	Required	Required

Because run-up/down calculations are required for Grid C, detailed dry land topographical data is required. Run-up calculations can be enabled for both Grid A and Grid B (if it is enabled for one, it must be enabled for both), in which case detailed topography is required. For Deformation Phase and Propagation Phase calculations, and for Grid A and Grid B calculations performed without run-up modeling, shorelines are defined by a minimum value determined by the modeler.

The spatial resolution recommendations for the finite difference grids derived from DEM data sets are shown below.

Table 4 MOST Digital Elevation Model Grids Spatial Resolution

MOST Stage	Recommended Resolution	Lowest Required Resolution*
Deformation/Propagation	1 arcminute (~1800 m)	4 arcminutes (~7300 m)
Inundation:		
Grid A (Outer)	36 arcseconds (~1080 m)	2 arcminutes (~3600 m)
Grid B (Intermediate)	6 arcseconds (~180 m)	18 arcseconds (~500 m)
Grid C (Inner)	≤ 1 arcsecond (≤ 30 m)	2 arcseconds (60 m)

*Note: Equivalent meter value on the Equator.



Constructing DEM Data Sets

To correctly model a tsunami requires that the DEM data grids not only meet the resolution and content requirements listed above, but must be expressed on a self-consistent and valid geographic reference system, defined in terms of a proper horizontal and vertical datum. DEM data sets are typically obtained from a range of sources, many of which do not use the same reference framework.

Defining DEM Parameters

Defining DEM parameters—specifying the simulation’s reference framework—is the first step in creating a valid finite difference DEM data set that can be used by MOST. The required parameters are essentially the same parameters that are used for any bathymetric or shoreline mapping, including:

- The coordinate system used.
- The reference system for geographic information ([horizontal datum](#)).
- The reference system for elevations and depths ([vertical datum](#)).
- The units.
- The extent and location of the tsunami target region (the area for which inundation is being modeled).

The recommended parameter set for MOST simulations for the United States and its territories is shown below.

Table 5 Recommended MOST Data Parameters

Coordinate System	Coordinate System: Geographic Decimal ($\pm 180^\circ$ longitude)
Horizontal (x, y) datum	World Geodetic System of 1984 (WGS84)
Vertical (z) datum	Mean High Water
Horizontal units	Decimal degrees
Vertical units	Meters

Choosing Grid Data

Several data sources are available to build DEMs. Table 6 provides a short list of recommended data sources from U.S. agencies. Some of these agencies provide low-resolution DEMs (e.g., ETOPO2) that are generally adequate for propagation modeling. For propagation, modelers can use these readily available grids or build their own. For inundation modeling, it is recommended that modelers build their own high-resolution grids. Venturato et al. (2005) and Venturato et al. (2004) provide details on the methodology of grid development.



Table 6 Some Recommended Sources of DEM Data

Coverage	Sources	Type	Links
Global	ETOPO2	bathymetry, topography	http://www.ngdc.noaa.gov/mgg/global/global.html
	GEBCO	bathymetry, topography	http://www.ngdc.noaa.gov/mgg/gebco/gebco.html
U.S. and its territories	NOAA	bathymetry, topography, shoreline, datum	http://www.ngdc.noaa.gov/ http://www.nos.noaa.gov/
	USGS	topography, photography, bathymetry	http://seamless.usgs.gov/
	USACE	bathymetry, shoreline	http://www.usace.army.mil/
	State agencies, universities	various	various
Local region	Local Agencies	various	various

DEM Set Compatibility

Note that all DEM resources must use the same set of defining parameters—reference system, units, and the horizontal and vertical datum—and therefore a modeler should use discretion in choosing DEM input resources, noting the requirement that all DEM input be translated to the same parameters and be validated against each other. Not converting all DEM data to a common set of reference parameters will create unphysical behavior by introducing discontinuities in ocean depth values, shoreline specification, and elevation. A number of useful tools exist to convert data from one parameter set to another. For a list of recommended tools, see [GIS Software](#).

Some problems involving badly-combined DEM data, particularly Deformation Phase and Propagation Phase simulation modeling open-ocean tsunami propagation (due to its use of long wavelength components of the tsunami model), can be ameliorated by using the MOST tool **bath_corr** to smooth the DEM grids. Note, however, that smoothing data grids will not be sufficient for high-resolution calculations with nested grids of different resolution and different sources, where significant differences between smoothed grids invalidate calculations.

The graphic below displays the difference in vertical coordinates of two nested grids where grids do not match well. This mismatch will cause significant anomalies in the MOST model if the grids are not repaired.

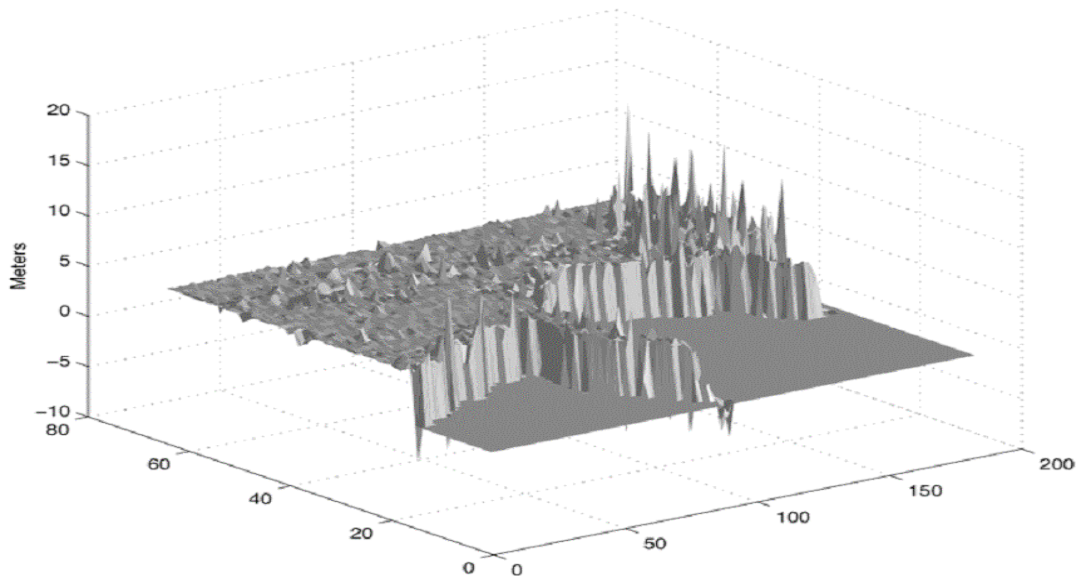

Figure 1: Grid Mismatch—The Difference in Vertical Coordinates Between Two Nested Grids

DEM grids must be analyzed for consistency prior to using the model. When nesting or combining grids, make sure that an overlap region exists where nodes from each grid have the same latitude and longitude. This overlap allows for a consistency check on the DEM data across different grid resolutions and across boundaries by verifying that there is little or no difference ($\leq 1\%$) between the ocean depth/elevation data found for the same point on two grids of differing resolution.

For example, during an Inundation Phase calculation where Grid C has six times the resolution of Grid B, (for example, 6 arcseconds as opposed to 1 arcsecond) a best practice is to define these grids so that the x,y coordinates for every sixth point on Grid C match the x,y coordinates of Grid B, and then check to see if the grids' z values (depth/elevation) match. Similarly, the overlap of the Propagation Phase grid and the coarsest and largest grid used during the Inundation Phase should also be checked.

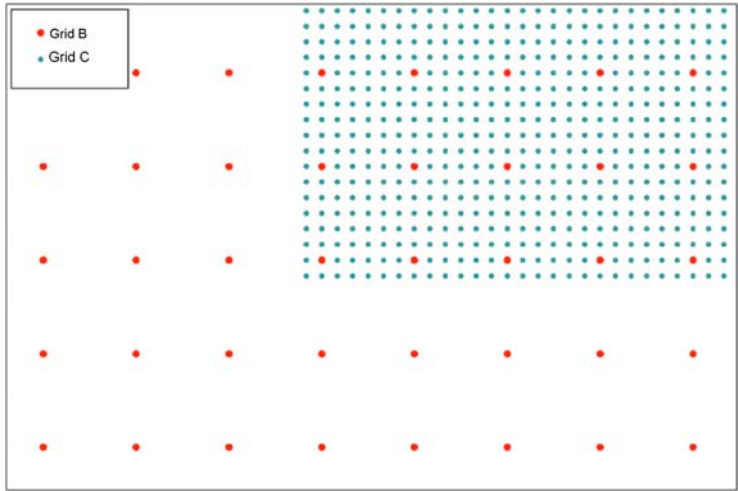

Figure 2: Matching Nested Grids

It is good practice to have whole number ratios of grid resolutions, and all grid points should be defined with a linear relation to the same origin. Since this practice may not always be possible, MOST supports non-uniform input gridding. In these cases, it is worthwhile to try to find some points that have the same or close geographic (x, y) values and to check vertical values—even if this requires interpolation.

Seismic Inputs

Significant changes to the ocean floor along a [fault plane](#) are characterized by a [strike](#), a [dip](#), a [slip](#) or [rake](#) angle of the fault plane; the ocean floor [slip magnitude](#) (dislocation) along the [fault plane trace](#); and the [epicenter](#) of the seismic event responsible for the undersea deformation.

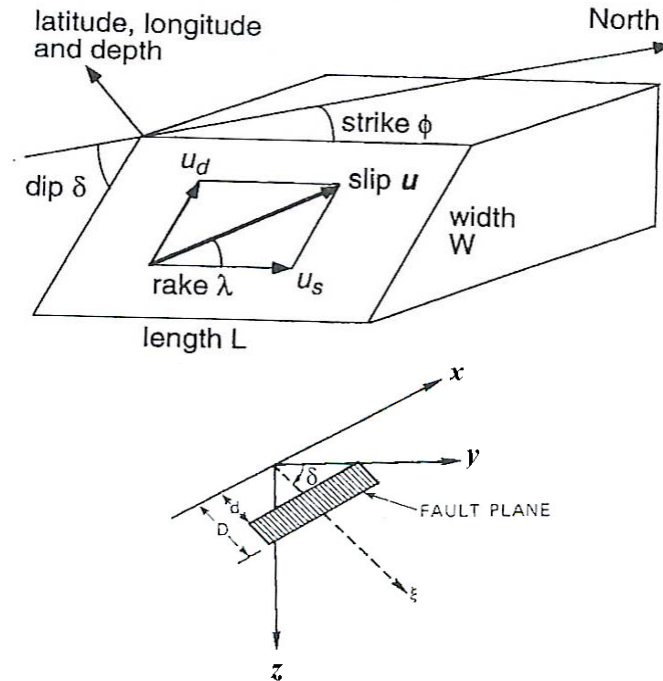

Figure 3: Earthquake Fault Parameters and Geometry System

Sea floor dislocation due to a rupture along a fault is expressed in terms of a [deformation rectangular area](#)—a region of ocean bottom bisected by the [fault trace](#), with an orientation determined by the [strike](#) angle.

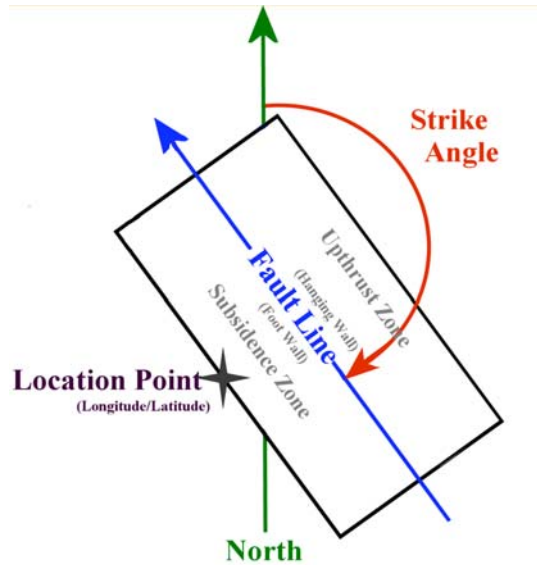

Figure 4: Deformation Rectangle

The fault line projects through the center of the deformation rectangle and divides the rectangle into a region of upthrust on the [hanging wall](#) side of the fault, and a region of subsidence on the [foot wall](#) side of the fault. The center of the deformation rectangle side parallel to the foot wall (on the subsidence side of the rectangle) is its location point or location reference—the point referred to by the longitude and latitude of the rectangle.

Using Multiple Deformation Rectangles

A given deformation rectangle should closely conform to a particular disruption occurring on the ocean floor. To model a real-world seismic fault, you need to decompose the rectangle into multiple deformation rectangles that are as contiguous and non-overlapping as possible.

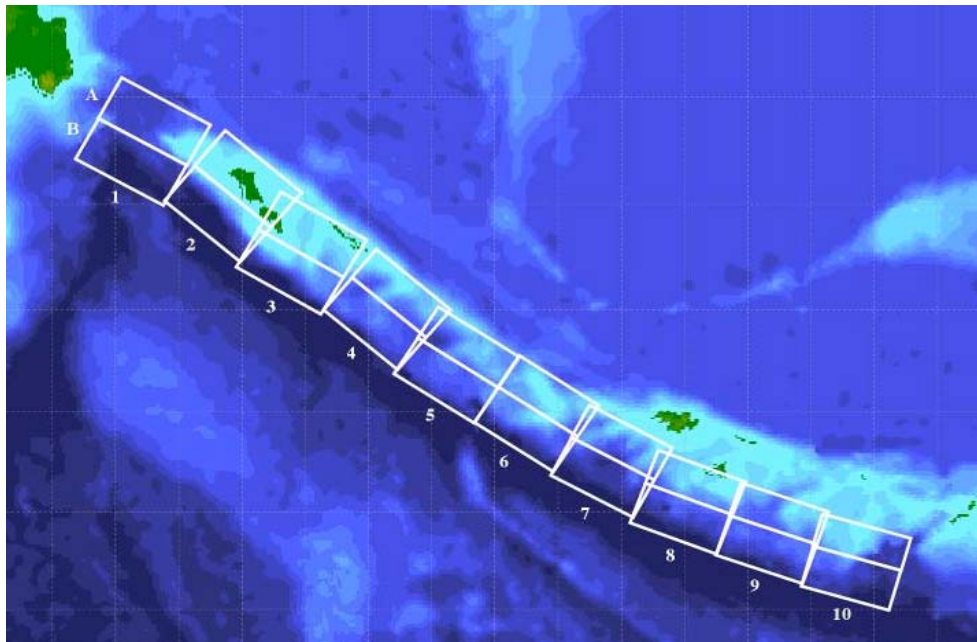

Figure 5: Fault Decomposed to Reformation Rectangles

Note that the **deform** executable processes one deformation rectangle at a time and writes the output to the file **deform.dat**. Modeling a complicated undersea seismic event requires several runs of **deform**, each on a different rectangle; therefore, be sure to rename each output **deform.dat** file so that all the files are available as input to Propagation Phase calculations.

Obtaining Fault Information

[PMEL](#) provides the following Web site that provides information such as slip, rake, dip, strike, and epicenter information for a range of historic fault sites:

- Facility for the Analysis and Comparison of Tsunami Simulations (FACTS)
<http://sift.pmel.noaa.gov/FACTS/main.pl>

For additional information about many significant faults world-wide, historic information about particular seismic events, and where to obtain reports on current seismic events, see the [Seismic Information Data Resources](#).

Input Correction Tools

Bathymetric data sets often need to be altered from their original form, for instance, to:

- Construct a set of telescopic grids for use during the inundation phase.
- Correct computationally problematic features that may appear in the bathymetric data.

To help you modify bathymetric data, the MOST package includes a [bathymetry](#) cropping and re-sampling tool called **bath_sample** and a bathymetry correction tool called **bath_corr**.



bath_sample

The **bath_sample** tool allows the modeler to reduce the original extent and resolution of a bathymetric data set by:

- Defining the boundaries of a subset of the original data covering the desired extent.
- Specifying the desired density of nodes present in the resulting grid.

bath_sample Data Inputs

The only data input required by **bath_sample** is the DEM file to be processed. For information on the format of DEM data files, see the [DEM Data File Format](#) section in the [Reference Guide](#) chapter.

Running bath_sample

Command input to **bath_sample** includes:

- A path to the DEM file to be processed.
- The indices of the first and last nodes in *x* (longitude) and *y* (latitude) that define the boundaries of the region of interest.
- The level of resolution reduction expressed in terms of the stride or number of nodes to be skipped between two nodes in the original file that will be saved to the output file.

The resulting data is stored in an output file that has the same name as the input file, with the extension ".s" appended to it. For a detailed description of **bath_sample** parameters, see [bath_sample.exe Command Inputs](#).

Sample bath_sample Execution

The **bath_sample.in** example shown below uses the 2551 by 1900 node file *indo2min* as input, and selects every fifth node in *x* (longitude—starting with node six (6) and ending with node 2400—and every fourth node in *y* (latitude)—starting at node ten (100) and ending at node 1800. A 479 by 426 node output file *indo2min.s* is created.

```
> ./bath_sample.exe
Reading Bathymetry
Bathymetry filename: indo2min
Grid dimensions in X,Y: 2551 1900
Geographic area (E-W): 35.017 -- 120.017
Geographic area (S-N): -35.010 -- 25.045
ALONG X:
Saving grid every n-th node, n= 5
... starting from: 6
6 35.18333degr E
... until: 2400
2400 114.98333degr E
ALONG Y:
Saving grid every n-th node, n= 4
... starting from: 100
100 -32.26278degr N
... until: 1800
1800 21.98939degr N
Writing surface into file
```



```
indo2min.s  
New dimensions: 479 426
```

Note that the program does not protect against overwriting, nor check the validity of the input parameters.

bath_corr

The **bath_corr** tool supports the smoothing of DEM data and determines correct configuration parameters for Propagation Phase and Inundation Phase calculations. The **bath_corr** tool searches the DEM file for bathymetric features that could cause instability in MOST calculations. In particular, **bath_corr** finds data indicating steep bathymetric gradients (mainly due to limitations of current bathymetric databases) or single-node features such as reefs, islands, and (for high-resolution computations) breakwaters. The features in the data are corrected in the data file such that the changes cause minimal impact on calculations.

When determining corrections to input data, **bath_corr** also obtains an estimate of fastest-wave velocity on the computational domain defined by the DEM data. This estimate allows the program to return to the modeler a maximum time step that satisfies the [Courant, Friedrichs, and Lewy \(CFL\) stability condition](#) for a given input data set.

All grids used by MOST—the initial basic DEM data set used by **deform** and **propagation**, and nested grids (Grid A, Grid B, and Grid C) used with **inundation**—should be processed using **bath_corr**. However, using **bath_corr** may not be sufficient to ensure that DEM input is compatible with the calculations. You should examine **propagation** and **inundation** output to determine if any problems exist. For more information, see [Troubleshooting Tsunami Wave Evolution Programs](#).

bath_corr Data Inputs

The **bath_corr** tool uses the same DEM file inputs as the Deformation Phase, Propagation Phase, and Inundation Phase. For information on the format of DEM data files, see the [DEM Data File Format](#) section in the [Reference Guide](#) chapter.

Running bath_corr

Command input to **bath_corr** can be supplied interactively or by means of input redirection. Required input includes the following:

- A path to a valid DEM file.
- An estimate of the maximum expected tsunami wave height (MAX_WAVE_HEIGHT).
- A shallow depth cutoff for bathymetric correction (MIN_DEPTH_THRESH).
- A steepness threshold (STEEPNESS_THRESHOLD).

For a detailed description of the **bath_corr** parameters, see [bath_corr.exe Command Inputs](#).

For each grid node that is corrected, the old and new values are written to *stdout*. Corrected DEM data is written to a file called **Bat.corrected**. Typically, **bath_corr** is applied iteratively, with the output from one **bath_corr** run used as input for the next, until the updated bathymetric data file (**Bat.corrected**) does not change over successive iterations. Note that the program does not check before overwriting previous output files.



When specifying the minimum depth cutoff (MIN_DEPTH_THRESH), note the following:

- Any DEM data with depths less than MIN_DEPTH_THRESH are not corrected.
- To make correction all the way to the shoreline, set MIN_DEPTH_THRESH to zero (0).
- In general, the value of MIN_DEPTH_THRESH should be greater than or equal to the minimum depth values used in Inundation Phase or Propagation Phase calculations.

When specifying the MAX_WAVE_HEIGHT value, note the following:

- MAX_WAVE_HEIGHT adds the height of an estimated wave to the bathymetric depth, allowing a more accurate calculation of the effect of variations in ocean depth on the steepness gradients by **bath_corr**.
- The sensitivity of bathymetric calculations due to corrections determined by the value of this parameter is relatively limited, particularly in deep water.
- If no reasonable estimate of wave height is available, setting MAX_WAVE_HEIGHT is acceptable, although it may require more iterations of **bath_corr** to stabilize the output file.

When using STEEPNESS_THRESHOLD, which ranges in value from 0.0-1.0, to control the size of the steepness gradient allowed to be present in the [bathymetry](#), note the following:

- Setting the STEEPNESS_THRESHOLD to a value of 1.0 indicates the greatest degree of bathymetric discontinuity—this setting will modify the smallest fraction of the input data set. For this reason, a steepness threshold of 1.0 is generally a good initial choice.
- If correcting bathymetric data with **bath_corr** does not seem to converge, consider using increasingly smaller values of the STEEPNESS_THRESHOLD.

Sample **bath_corr** execution

Below is sample output from one iteration of **bath_corr**. The input is equivalent to:

```
10          'MAX_WAVE_HEIGHT' (m)
10          'MIN_DEPTH_THRESH' (m)
1           'STEEPNESS_THRESHOLD'
Bat.corr    'BATHYMETRIC_FILE'
```

The output contains a list of all corrections that were made to the input DEM data set, and as a final output, the maximum time-step size compliant with the CFL wave-propagation modeling condition for the corrected data set (in **bold**).

```
./bath_corr
' Max wave height estimate:
Minimum depth in computation:
Steepness threshold:
Reading Bathymetry
Bathymetry filename:  Corrections along X
1 point: i,j= 113 1824
Original : 378. 19.5 11.
Corrected: 378. 107.7512 11.
2 point: i,j= 124 1781
Original : 329.73 19.5 11.
Corrected: 329.73 81.2710559 11.
```



3 point: i,j= 140 462
Original : 476. 19.5 -54.
Corrected: 476. 173.7248 -54.
.
.
.
207 point: i,j= 2537 870
Original : 11. 19.5 375.
Corrected: 11. 105.9968 375.
208 point: i,j= 2549 1298
Original : 590. 19.5 9.
Corrected: 590. 269.12 9.
Writing surface into file Bat.corrected
Maximum dt= 11.7971563
at depth 6777.m; i,j= 2026 5



Performing Tsunami Modeling Using MOST

This section provides detailed information about the Deformation Phase, Propagation Phase, and Inundation Phase.

Deformation Phase Modeling

The location and magnitude of initial ocean surface displacement due to a rupture along an undersea fault can be shown to be critical source inputs to effective modeling of open-ocean tsunami propagation (Titov et al. 1999). The Deformation Phase of a MOST simulation uses the **deform** executable to calculate the contribution that dislocation of a given region of the sea floor (known as a [deformation rectangular area](#)) makes to an initial tsunami wave front.

Deformation Phase Input Data

A Deformation Phase calculation uses input information about the rupture along an undersea fault, expressed as a deformation rectangle, and a DEM data set.

DEM Inputs to deform

MOST DEM finite difference grids are defined in terms of a two-dimensional (x,y) coordinate system with a digital elevation value (z) specified at each node. The DEM input grid must be identical to that used in Propagation Phase calculations. For information on the format of DEM data files, see the [DEM Data File Format](#) section in the [Reference Guide](#) chapter. A detailed discussion on how to obtain and manage DEM inputs to **deform** and for all other phases of MOST simulations is found in the [Most Digital Elevation Models](#) section.

Seismic Data Inputs to deform

The specification of a deformation rectangle and the size (in terms of nodes on a DEM finite difference grid) of a target sub-grid region on the ocean surface provide the seismic input data to **deform**.

A deformation rectangle is defined using the following parameters:

- latitude of the deformation rectangle
- longitude of deformation rectangle (in East degrees)
- length of deformation rectangle (in km)
- width of deformation rectangle (in km)
- seismic [epicenter](#) depth (in km)
- [slip magnitude](#) (in m)
- [strike angle](#)
- [dip angle](#)
- [rake angle](#) (also known as the [slip angle](#))

All of these values are supplied to the *stdin* of **deform**.



Running deform

The **deform** executable requires the following input:

- Command input provided to *stdin*. For more information, see the [deform command](#) section in the [Reference Guide](#) chapter.
- Parametric input. The read-only file **static.dat** that is provided with the MOST distribution contains parameters that are used to integrate the effect that ocean floor changes, defined by a given deformation rectangle, have on the ocean surface. This file should not be modified. For more information, see the [deform](#) command section.
- DEM input. The Deformation Phase simulation data input file contains bathymetric values specified on a two-dimensional finite difference grid covering the geographic region that is to be used as input to **propagation** during Propagation Phase calculations. The DEM input file used as input to **deform** must be the same as that used as input to **propagation**. For more information, see the [DEM Data File Format](#) section in the [Reference Guide](#) chapter.

Configuring deform

The command input can be provided to **deform** either interactively or by means of input redirection. Command input for **deform** includes the following:

- The name of the file containing DEM data.
- The location and dimensions of the deformation rectangle.
- The size, in nodes, of the subsection of the input DEM finite difference grid where ocean surface levels will be modified by Deformation Phase output.
- The [dip](#), [strike](#), and [slip](#) or [rake angle](#) along the fault.
- The [slip magnitude](#).
- The depth of the [epicenter](#) of the seismic event responsible for the fault activity.

For more information on Deformation Phase configuration command inputs, see [deform Command Inputs](#).

When running **deform**, note the following:

- The executable does not protect against overwriting existing **deform.dat** output files.
- DEM input data should be smoothed using **bath_corr**.
- The magnitude of a deformation rectangle's slip can be scaled from the Deformation Phase output during the Propagation Phase using **propagation**. The total slip magnitude used in calculating open-ocean tsunami propagation is the product of the slip magnitude specified during the Deformation Phase and a slip magnitude scale provided during the Propagation Phase. This allows simulations to reuse the output of a unit slip magnitude from a Deformation Phase calculation for a variety of seismic intensities by simply scaling the slip for the Propagation Phase.



Notes on Using deform

The **deform** executable creates the output file **deform.dat**, which contains corrections to the ocean surface. For detailed information about **deform.dat**, see [deform Data Outputs](#) in the [Reference Guide](#) chapter. Note that each execution of **deform** overwrites any existing **deform.dat** file.

Sample Deformation Phase Simulation

The example below uses the following command input from the file **deform.in**:

```
cat deform.in
topo4edge.corr
150,150      'X/Y Dimensions of bathymetric output area
287.2735    'Longitude (deg):'
-35.69531   'Latitude (deg):'
100         'Length (km):'
50          'Width (km):'
18          'DIP (deg):'
90          'RAKE (deg):'
19          'STRIKE (deg):'
1           'SLIP (m)',u0
5           'DEPTH (km):',htop
```

Redirecting **deform.in**, shown above, to **stdin** for **deform** returns the following output to the screen:

```
deform < deform.in
Bathymetry filename:topo4edge.corr
Input size of the source array
x-nodes (<500),y-nodes (<500): 150 150
Coordinates of the source center:
Longitude, E (deg):
287.2735
Latitude, N (deg):
-35.69531
STATIC is working
Length (km):
100.
Width (km):
.50
DIP (deg):
18.
SLIP (deg):
90.
STRIKE (deg):
19.
SLIP AMOUNT (m)
1.
DEPTH (km):
5.
445.883514 457.191254
Integration area 41 x 21
Writing results
```

The output to the screen echoes the input from *stdin* and from *static.dat*.

Deformation Phase Outputs

The Deformation Phase output file contains only the nodes of the sub-grid, and the location specified in nodes, of the Northwest corner of the sub-grid within the larger DEM grid. For more information about the format of *deform.dat*, see [deform Data Outputs](#) in the [Reference Guide](#) chapter.

Because *deform* tools map a 'shadow' of the ocean floor deformation onto a subsection of the finite difference grid covering the ocean surface, care needs to be taken in defining both the deformation rectangles used as input and the sub-grid areas that will receive output.

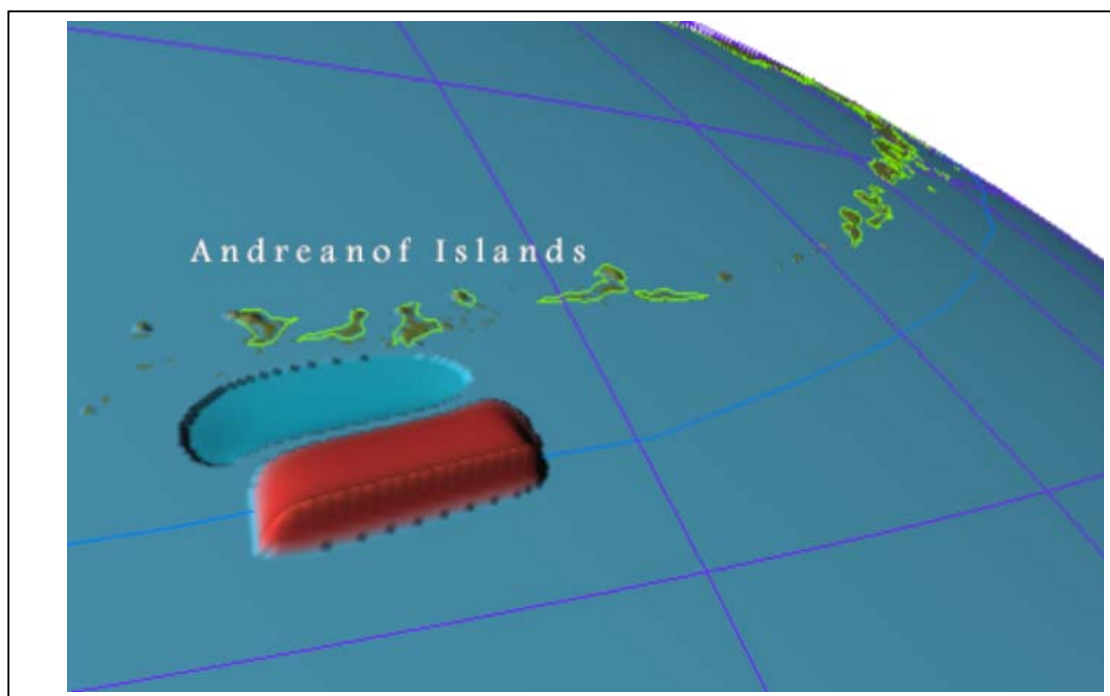

Figure 7: Projection of Deformation Rectangle to Deformation Phase Output Area

The exact location of the *deform* output sub-grid target is uniquely determined by *deform* once the user specifies the location of the deformation region and the number of nodes in the deformation sub-grid. Generally, however, the sub-grid should be roughly centered over the deformation rectangle.

Troubleshooting Deformation Phase Simulations

The output sub-grid targeted by *deform* should contain the bulk of surface disruption due to a given deformation rectangle input; therefore, the correctness of a Deformation Phase run can be checked by:



- Ensuring that the location of the output sub-grid chosen by **deform** is approximately centered over the deformation rectangle.
- Verifying that the data in **deform.dat** shows only minor displacements along the edges of the DEM output sub-grid.

As overlap is permitted for output sub-grids used as input to the Propagation Phase, choosing a large output sub-grid—even one covering the entire area of a fault rupture straddling multiple deformation rectangles—may be good practice.

Propagation Phase Modeling

The Propagation Phase models the open-ocean evolution of a tsunami using a depth-integrated version of Nonlinear Shallow Water ([NSW](#)) wave equations in two spatial and one temporal dimension. The output of a Propagation Phase calculation—the wave's height, and zonal and meridional velocities—is saved for selected time steps and provides the initial and boundary conditions for Inundation Phase.

Propagation Phase Input Data

The **propagation**-based calculations use two types of input: one DEM data set, and one or more ocean surface displacement data sets. Each ocean surface displacement data set is derived, using **deform**, from one of the deformation rectangles modeling a section of the rupture of an underwater fault. Propagation Phase calculations superimpose the ocean surface displacement information derived from the Deformation Phase inputs onto the initial sea level elevation grid to define an initial tsunami wave.

Digital Elevation Model Inputs to propagation

The **propagation** DEM input data set is expressed as a finite difference grid. However, the Propagation Phase DEM data set should still be smoothed using **bath_corr** to remove any problematic steepness discontinuities and unphysical single-node features. For more information on DEM files, see the [DEM Data File Format](#) section in the [Reference Guide](#) chapter.

Ocean Displacement Inputs to Propagation Phase

The ocean displacement inputs to **propagation** are created by **deform**. These inputs define the initial tsunami wave state and provide forcing functions to Propagation Phase calculations. All Deformation Phase output produced by **deform** and used as input to the Propagation Phase must be calculated using the same DEM data set that was used as input to **propagation**. Multiple Deformation Phase outputs can be used as inputs to **propagation**. This allows the decomposition of complicated undersea faulting into several deformation rectangles. Ocean surface displacements due to a deformation rectangle are mapped to a subsection (maximum size 500 × 500) of the nodes that make up the DEM finite difference grid. For more information on **deform** output file format, see [Deformation Output File Format](#).



Running propagation

The **propagation** executable requires the following input:

- Command input provided to *stdin* on **propagation**. For more information, see [Configuring propagation](#) below and [propagation Command Inputs](#) in the [Reference Guide](#) chapter.
- DEM input. A simulation using **propagation** requires a data input file that contains bathymetric values specified on a two-dimensional finite difference grid covering the geographic region of Propagation Phase calculations. The DEM input file used in Propagation Phase calculations must be the same file used by **deform** to produce Deformation Phase inputs to **propagation**. For more information on the DEM file, see the [DEM Data File Format](#) section in the [Reference Guide](#) chapter.
- Tsunami conditions specification provided by **deform**. The output files from one or more deformation rectangles used in Deformation Phase calculations are used by **propagation** to define the initial state of the tsunami that is to be propagated across open ocean. For more information on obtaining Deformation Phase outputs, see [Deformation Phase Modeling](#). Background on the Deformation Phase output file formats is available under the [Deformation Output File Format](#) section of the [Reference Guide](#) chapter.

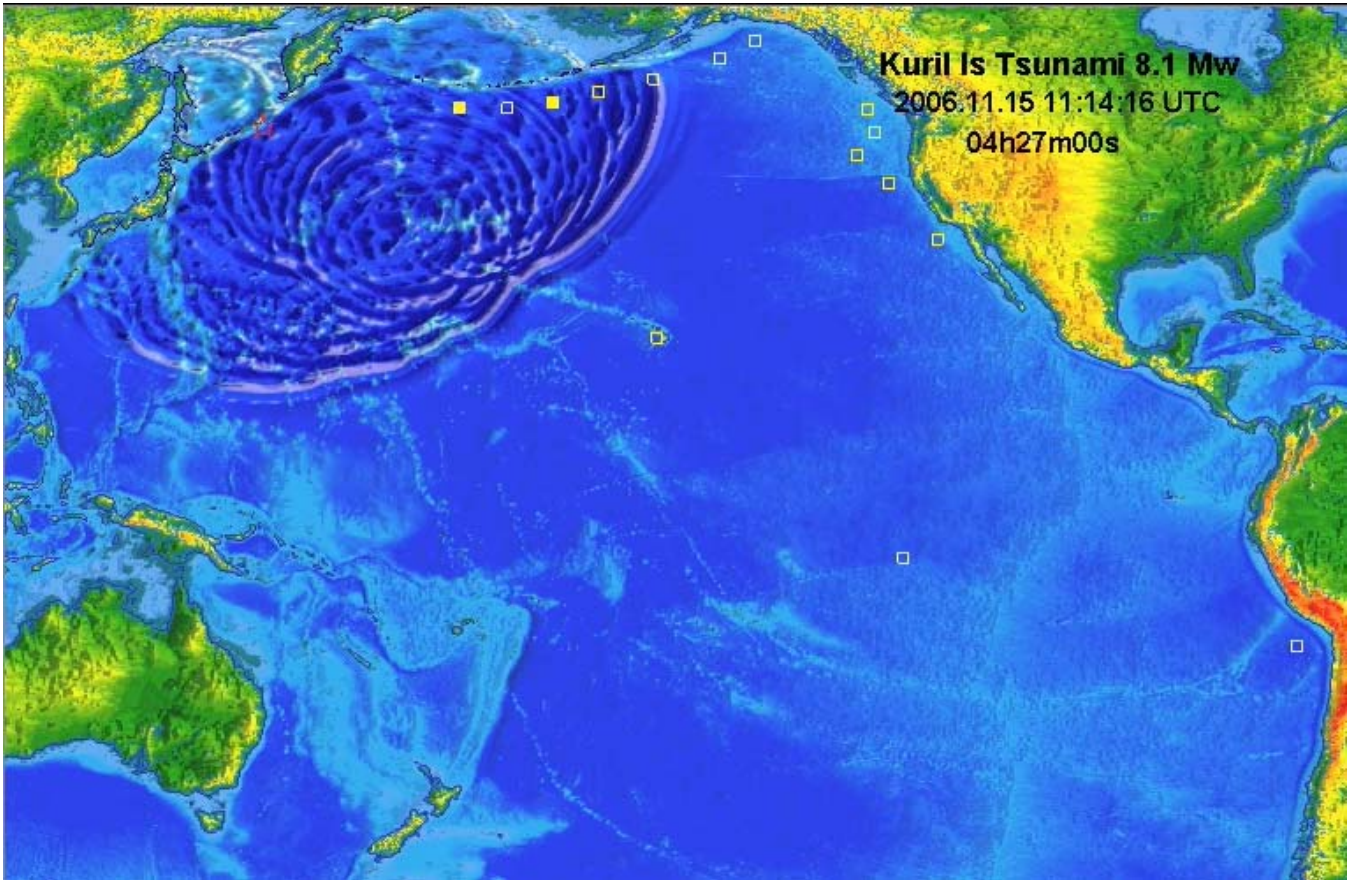

Figure 8: DEM and Tsunami Propagation

The **propagation** executable produces three output files, each containing the time-stepped evolution of one of the three components of the wave equations solution. These tsunami components are:

- Wave height in centimeters.
- Meridional velocity in centimeters/second.
- Zonal velocity in centimeters/second.

Configuring propagation

A Propagation Phase simulation is defined by providing **propagation** with run parameters either interactively or by redirecting a file to *stdin*. Input parameters include the following:

- The name of the file containing DEM data.
- The specification of the initial state of the tsunami to be propagated expressed in terms of:
 - The number of Deformation Phase output files.
 - The name of each Deformation Phase output file.
 - A scaling factor for each Deformation Phase input to be applied to the [slip magnitude](#).
- The size and number of finite difference time steps used in the Propagation Phase calculations.



- A base name for all **propagation** output files, as well as the specification of the frequency (OUTPUT_FREQUENCY) and starting point (OUTPUT_START) for saving Propagation Phase information.
- A minimum depth boundary value for Propagation Phase calculations.

For more information on Propagation Phase configuration command inputs, see [propagation Command Inputs](#).

Notes on Using propagation

When running **propagation**, note the following:

- DEM input data should be smoothed using **bath_corr**.
- No topographical information is required. The minimum depth setting (shown in **bold** below) effectively defines shorelines for **propagation** calculations.

```
./bath_corr <bath_corr.in
' Max wave height estimate:
Minimum depth in computation: 10
.
.
.
Writing surface into file Bat.corrected
Maximum dt= 11.7971563
at depth 6777.m; i,j= 2026 5
```

- The size of the specified time step must meet the Courant, Friedrichs, and Lewy (CFL) stability condition for finite difference wave propagation as a function of depth and grid density. A maximum time-step value can be obtained from the last lines of the **bath_corr** output, as shown in **bold** below:

```
./bath_corr <bath_corr.in
' Max wave height estimate:
Minimum depth in computation: 10
.
.
.
Writing surface into file Bat.corrected
Maximum dt= 11.7971563
at depth 6777.m; i,j= 2026 5
```

For more information on using the CFL condition, see [CFL Stability Condition](#).

- The product of the time-step size and number of time steps (shown in **bold** in the sample output below) defines the lifetime of the simulation, and should be larger than the expected travel time for the tsunami.

```
propagation < indo2min.in
Input minimum depth for offshore (m): 10.
Input time step (sec): 7.5.
Input amount of steps: 3600
Input number of steps between snapshots: 12
```



...Starting from: 600

- The minimum ocean depth cutoff to Propagation Phase calculations typically has a value of 10 to 20 m:

```
propagation < indo2min.in
Input minimum depth for offshore (m): 10.
Input time step (sec): 7.5.
Input amount of steps: 3600
Input number of steps between snapshots: 12
...Starting from: 600
```

This will not pose a problem for a MOST simulation if the ocean region used in the Inundation Phase calculation is defined with a border facing the incoming tsunami of the Inundation Phase's outer, coarsest Grid A, which should be defined at appropriate depths, for example 1000 to 1500 m.

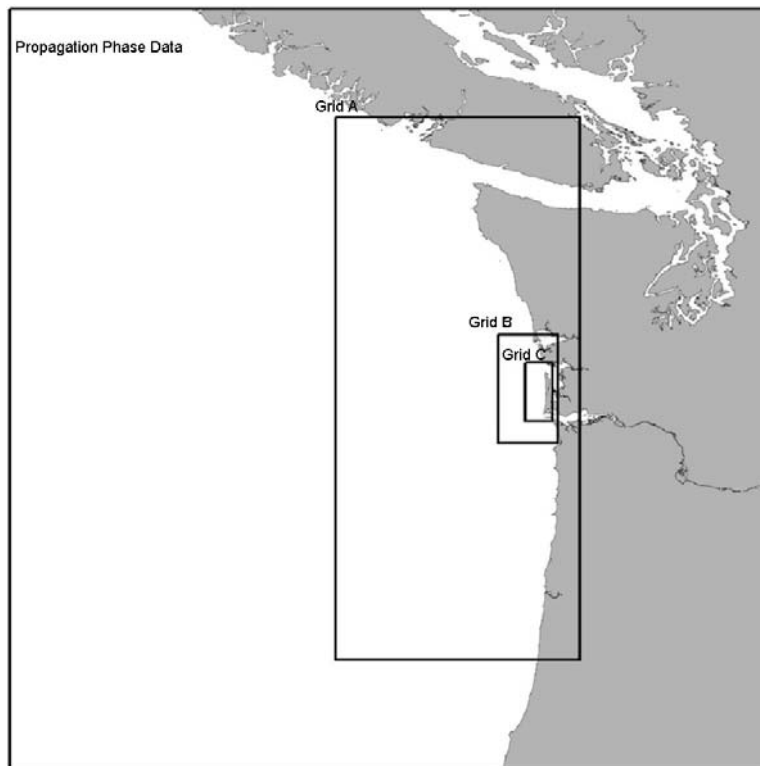

Figure 9: Propagation Phase and Inundation Phase Data Grids

Be sure to choose a cutoff depth so that the ocean region modeled by **propagation** almost completely surrounds the region that is used during Inundation Phase calculations.

- The ocean surface displacement calculated from the output of **deform** for a given deformation rectangular area and used as input to **propagation** depends on the amount of sea floor dislocation along the fault line bisecting the deformation rectangle. The actual value of sea floor dislocation across a deformation rectangle used in the Propagation Phase calculations is the product of the [slip magnitude](#) supplied to **deform** when it created Deformation Phase output (and supplied as



input to the Propagation Phase), and the value of the [slip magnitude scale factor](#) specified to **propagation**.

For example, if Deformation Phase output is calculated using a slip magnitude of **1.56 m**, and copied to a file named **src1_lg.dat** as shown in **bold** below:

```
deform < deform.in
Bathymetry filename:topo4edge.corr
Input size of the source array
x-nodes (<500),y-nodes (<500): 150 150
Coordinates of the source center:
.
.
.
DIP (deg):
 18.
SLIP (deg):
 90.
STRIKE (deg):
 19.
SLIP AMOUNT (m)
1.56
.
.
.
Writing results
cp deform.data src1_lg.dat
```

And a slip magnitude scale factor of **5.6** is used for **src1_lg.dat** when running **propagation** interactively (see the **bold** output below):

```
propagation
Input minimum depth for offshore (m):
10.
 10.
Input time step (sec):
10.
 10.
.
.
.
FAULT 1 Input filename:
src1_lg.dat
Input slip(m)
5.6
.
.
.
```

The Propagation Phase calculation will use **8.74** meters as the value of ocean floor dislocation.



Propagation Phase Sample Run

The example below shows the screen output from **deform** for the command input contained in the file **indo2min.in**. Note the following input specifications:

- The **indo2min.in** input file requests a Propagation Phase calculation using the Deformation Phase outputs from three deformation rectangles as initial conditions.
- The tsunami wave state will be saved every six time steps, starting with time step twelve.
- The base name for all three data output files will be **indo2min**.

The **indo2min.in** input file has the following values:

```
10          'MIN_DEPTH_THRESH (M)
10          'Timestep (SEC)
3600       'NUMBER_OF_TIMESTEPS
6          'OUTPUT_FREQUENCY
12         'OUTPUT_START
indo2min.corr2  'BATHYMETRIC_FILE
3          'NUM_DEFORMATION INPUTS
src1_lg.dat   'DEFORMATION INPUT_FILE
20.        'SLIP_MAGNITUDE_SCALE_FACTOR (M)
src2_lg.dat   'DEFORMATION INPUT_FILE
20.        'SLIP_MAGNITUDE_SCALE_FACTOR (M)
src3_lg.dat   'DEFORMATION INPUT_FILE
20.        'SLIP_MAGNITUDE_SCALE_FACTOR (M)
indo2min     '<OUTPUT_PREFIX>
```

Input data is echoed to **stdout**, along with a log of each time step calculated and each time step when a state save occurs.

```
propagation < indo2min.in
Input minimum depth for offshore (m):  10.
Input time step (sec):  10.
Input amount of steps:  3600
Input number of steps between snapshots:  12
...Starting from:  6
Reading Bathymetry
Bathymetry filename:  longitude:  35.01667  120.0167
latitude:  -35.00977  25.04535
Input number of fault-planes:
FAULT 1  Input filename:          Input slip(m)
FAULT 2  Input filename:          Input slip(m)
FAULT 3  Input filename:          Input slip(m)
source location:  93.4722977  11.6049995
netCDF file prefix:  *indo2min*
*
indo2min_ha.nc *
dimensions: 1276 950
netCDF initialization complete
time step 1 time =  10.sec
time step 2 time =  20.sec
```



```
time step 3 time = 30.sec
.
.
.
time step 3600 time = 36000.sec
output time step 6000
end most1_db
```

Note that only the location of the last deformation rectangle and the name of one of the three data output files are written to *stdout*.

Propagation Phase Outputs

The Propagation Phase saves each of the three components of the time-stepped tsunami solution state in its own [netCDF](#) file format. The base name of the output files is determined by the last command input to **propagation**. For the command input file **indo2min.in**, the base name (in **bold**) is **indo2min**.

10	'MIN_DEPTH_THRESH (M)
10	'TIMESTEP (SEC)
3600	'NUMBER_OF_TIMESTEPS
6	'OUTPUT_FREQUENCY
12	'OUTPUT_START
indo2min.corr2	'BATHYMETRIC_FILE
3	'NUM_DEFORMATION_INPUTS
src1_lg.dat	'DEFORMATION_INPUT_FILE
20.	'SLIP_MAGNITUDE_SCALE_FACTOR (M)
src2_lg.dat	'DEFORMATION_INPUT_FILE
20.	'SLIP_MAGNITUDE_SCALE_FACTOR (M)
src3_lg.dat	'DEFORMATION_INPUT_FILE
20.	'SLIP_MAGNITUDE_SCALE_FACTOR (M)
indo2min	'<OUTPUT_PREFIX>

Each of the three components—wave height, zonal velocity, and meridional velocity—is written to its own output file.

- Wave height information is written to a file with the suffix **_ha.nc**.
- Zonal velocity data is written to a file with the suffix **_ua.nc**.
- Meridional velocity data is written to a file with the suffix **_va.nc**.

For the example command input above, the output files are: **indo2min_ha.nc**, **indo2min_ua.nc**, and **indo2min_va.nc**. For more information on the format of output files, see the [Wave Evolution File Formats](#) section in the [Reference Guide](#) chapter.

Inundation Phase Modeling

The **inundation** executable models shoreline tsunami behavior, including onshore run-up. Tsunami behavior is modeled using input from **propagation**, the depth-integrated [NSW](#) wave equations computed on a set of nested DEM grids, and a run-up algorithm to predict onshore flooding. Inundation Phase output includes wave height, zonal velocity, and meridional velocity for each of the nested NSW calculations. The output is saved for selected time steps



Inundation Phase Input Data

Input to the **inundation** executable includes a set of nested DEM inputs and the output from the **propagation** calculations. Inundation Phase calculations are performed over all nested DEM grids, with the inundation algorithm being computed in the highest resolution, inner grid (Grid C) and possibly in outer grids A and B. The **propagation** outputs are used as a boundary and in some cases as initial conditions to the inundation run.

DEM Inputs to inundation

Inundation Phase modeling performs [NSW](#) calculations on three distinct, nested, but overlapping DEM finite difference data sets, referred to as [Grid A](#) (the largest area and coarsest finite difference data set), [Grid B](#), and [Grid C](#) (the smallest area and the finite difference data set with the highest resolution).

The finite difference grids are defined in terms of a two-dimensional (x,y) coordinate system with a digital elevation value (z) specified at each node. Depths below the [vertical datum](#) (nominal sea level) are expressed as positive values, and dry land elevations are expressed as negative values. Each grid is defined by its own data file, and the format of these data files is the same as that used for Deformation Phase and Propagation Phase calculations.

Grid A, covering the largest geographic area, defines the boundaries of **inundation** calculations. Because Grid C defines the target area for an Inundation Phase simulation—the area of primary interest for calculating the onshore tsunami run-up—**inundation** requires that the Grid C input data set contain topographical elevation information for dry land above the shoreline, as well as ocean depth measurements. As an option, onshore run-up can be calculated for both Grids A and Grid B, in which case the DEM data used to define these grids must contain topographical information. All three DEM input data sets should be smoothed using **bath_corr** to remove any problematic steepness discontinuities and to handle poorly-resolved single-node features.

For more information on DEM data files, see the [DEM Data File Format](#) section in the [Reference Guide](#) chapter.

Inundation Phase Open-Ocean Tsunami Propagation Input

The open-ocean tsunami evolution information that is output from **propagation** provides the boundary conditions for the edges of Inundation Phase calculations defined by Grid A and as the initial condition interpolated into the computational domain when the area under investigation has been subject to co-seismic displacement.

The **propagation** output is stored in three [netCDF](#)-formatted files, each containing the time-stepped values of one of the components of open-ocean tsunami propagation.

An Inundation Phase calculation may not strictly need all the saved time steps stored in the Propagation Phase. Typically, only the late time steps—the time steps covering the point where the tsunami arrives at the outermost Inundation Phase grid (Grid A)—are actually needed for **inundation** input. This data can be obtained by extracting only the needed time steps from a Propagation Phase output file, by using netCDF functionality or tools such as MATLAB[®] or Ferret, or by the choice of the start point for saving wave state to disk (OUTPUT_START) that can be supplied to **propagation** as a command input.



When **propagation** output files are used as input to **inundation**, the files must be renamed to comply with the following conventions:

- All input files containing Propagation Phase data must have a common **base name**.
 - Wave height information is contained in a file with the suffix **h.nc**.
 - Zonal velocity data is contained in a file with the suffix **u.nc**.
 - Meridional velocity data is contained in a file with the suffix **v.nc**.

For example, given a base name of **indo2min_**, the Propagation Phase input to **inundation** would be contained in **indo2min_h.nc**, **indo2min_u.nc**, and **indo2min_v.nc**. For more information on tsunami wave output files, see the [Wave Evolution File Formats](#) section in the [Reference Guide](#) chapter.

Running inundation

The executable **inundation** requires the following:

- Command input provided on the command line and from an input file. For more information on command inputs to **inundation**, see [Configuring inundation](#) below and [propagation Command Inputs](#) in the [Reference Guide](#) chapter.
- Three DEM input files, each containing data for one of the Inundation Phase calculation grids ([Grid A](#), [Grid B](#), [Grid C](#)). Each input file contains DEM values specified on a two-dimensional finite difference grid covering the geographic region of Propagation Phase calculations. Because onshore run-up of the tsunami is calculated for Grid C, this input file must contain dry land elevation (topographical) data as well as ocean depth information. If run-up is also calculated for Grid A and Grid B, these input files must also contain topographic information.

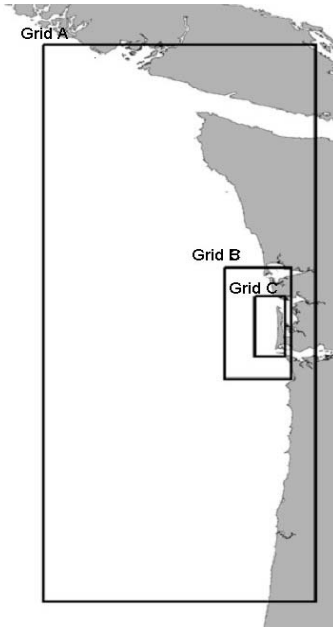

Figure 10: Inundation Phase Nested Grids

For more information on the format of the DEM file, see the [DEM Data File Format](#) section in the [Reference Guide](#) chapter. For information on selecting appropriate DEM input, see [Constructing DEM Data Sets](#).

- Propagation Phase output files. Output from **propagation** calculations is used to provide boundary conditions for Inundation Phase simulations. For more information on tsunami wave output files, see the [Wave Evolution File Formats](#) section in the [Reference Guide](#) chapter.
- An estimated value of the Manning coefficient for bottom friction (resistance to run-up). For more information on run-up resistance and determining values for the Manning coefficient, see [Working with Manning Coefficients](#).

Configuring inundation

To configure Inundation Phase simulation, you need to specify the base names of output data files, Propagation Phase input files, and a directory containing parameter (DEM) data and command specification files:

```
inundation <OUTPUT_PREFIX> <INPUT_DATAFILE_BASE_NAME> <PARAMETERS_DIR>
```

The detailed specification of the execution of **inundation** is provided by the file **most3_facts_nc.in**, located under **PARAMETERS_DIR**.

The file **PARAMETERS_DIR/most3_facts_nc.in** specifies:

- The names of DEM data files for Grid A, Grid B, and Grid C, the location of directories containing Propagation Phase input data and Inundation Phase output data.
- Parameters defining boundary conditions on Inundation Phase calculations, including:



- The boundary (in terms of ocean depth and topographical elevation) between onshore and offshore calculations.
- A minimum wave height (obtained from Propagation Phase data) that defines the presence of the tsunami on the Inundation Phase calculation boundary.
- A maximum tsunami wave height to provide a check on runaway **inundation** calculations.
- A flag indicating whether Grid A and Grid B require run-up calculations.
- A value for the Manning coefficient.
- Time-stepping of finite difference calculations for all three input grids.
- The frequency and density of Inundation Phase output data.

For more detailed information on Inundation Phase configuration command inputs, see [inundation Command Inputs](#).

Notes on Using inundation

When running **inundation**, note the following:

- The Inundation phase makes no assumption on tides. DEMs are usually based on Mean High Water, providing a "worst" case scenario.
- It is recommended that DEM input data be smoothed using **bath_corr**.
- The Grid C DEM finite difference grid for **inundation** must include topographical information.
- If outer grid run-up is enabled (OUTER_GRID_RUNUP), then both Grid A and Grid B must include topographical information up to the contour line defined by OFFSHORE BOUNDARY; otherwise, Grid A and Grid B do not require dry land information in their Digital Elevation Model data.

In the example below, it is specified in **most3_facts_nc.in** that both Grid A and Grid B support run-up calculations and require topographical information.

```
5 'OFFSHORE_BOUNDARY (m)
0.1 'ONSHORE_BOUNDARY (m)
0.0009 'FRIC_COEFF (n**2)
1 'OUTER_GRID_RUNUP
300.0 'MAX_WAVE_HEIGHT
.90 'GRIDC_TIMESTEP (sec)
30000 'NUM_GRIDC_TIMESTEPS
9 'GRIDA_TIMESTEP_MULTIPLE
3 'GRIDB_TIMESTEP_MULTIPLE
180 'OUTPUT_FREQUENCY
0 'OUTPUT_START
1 'NODE_OUTPUT_FREQ
yakutat_2m_m.asc.s 'GRIDA_DATA
yakutat_24s_m.asc.s 'GRIDB_DATA
yakutat_4s_m.asc.s.s 'GRIDC_DATA
./ 'PROP_INPUT_DIR
./ 'OUTPUT_DIR
```

>more Output_Yakutat.lis

Site: Yakutat



```
Input prefix: 1946-
Input Directory: ./
Read Computational parameters: ./most3_facts_nc.in
  Minimum amplitude of input offshore wave (m): 0.001
  Input minimum depth for offshore (m): 5.
  Input "dry land" depth for inundation (m): 0.1
  Input friction coefficient (n**2): 0.0009
  Input runup switch (0 - runup only in gridC, 1 - runup in all grids): 1
```

- The size of the time step for all grids must meet the Courant, Friedrichs, and Lewy stability condition for finite difference wave propagation as a function of depth and grid density.

A maximum time-step value for each of the nested Inundation Phase grids should be found independently, which can be done by processing each grid through **bath_corr**, as seen in the example below:

```
./bath_corr <bath_corr.in
' Max wave height estimate:
Minimum depth in computation: 10
.
.
.
Writing surface into file Bat.corrected
Maximum dt= 11.7971563
at depth 6777.m; i,j= 2026 5
```

Grid C is the only grid used by **inundation** whose time step is explicitly set to a value in seconds (GRIDC_TIMESTEP). Finite difference update time steps for Grid A and Grid B are defined as multiples of the Grid C time step (GRIDA_TIMESTEP_MULTIPLE and GRIDB_TIMESTEP_MULTIPLE).

For stability, GRIDC_TIMESTEP, and GRIDC_TIMESTEP* GRIDA_TIMESTEP_MULTIPLE, and GRIDC_TIMESTEP* GRIDB_TIMESTEP_MULTIPLE must all meet the CFL condition, i.e., they should be smaller than dt_c , dt_b , and dt_a , respectively.

In the sample **most3_facts_nc.in**, this condition implies that .90 seconds meets the CFL condition for Grid C, 2.7 ($3 \times .90$) seconds meets the condition for Grid B, and 8.1 ($9 \times .90$) seconds meets the condition for Grid A.

```
5           'OFFSHORE_BOUNDARY (m)
0.1        'ONSHORE_BOUNDARY (m)
0.0009     'FRIC_COEFF (n**2)
1          'OUTER_GRID_RUNUP
300.0      'MAX_WAVE_HEIGHT
.90      'GRIDC_TIMESTEP (sec)
30000     'NUM_GRIDC_TIMESTEPS
9       'GRIDA_TIMESTEP_MULTIPLE
3       'GRIDB_TIMESTEP_MULTIPLE
180       'OUTPUT_FREQUENCY
0         'OUTPUT_START
1         'NODE_OUTPUT_FREQ
```



```

yakutat_2m_m.asc.s      'GRIDA_DATA
yakutat_24s_m.asc.s    'GRIDB_DATA
yakutat_4s_m.asc.s.s   'GRIDC_DATA
./                      'PROP_INPUT_DIR
./                      'OUTPUT_DIR

```

In this case, the ratio of time steps is 9:3:1, which means that the selected time steps should be compliant if GRIDC_TIMESTEP is compliant. For more information on using the CFL condition, see [Courant, Friedrichs, and Lewy \(CFL\) Stability Condition](#).

- The shoreline for an Inundation Phase simulation is specified by the OFFSHORE_BOUNDARY and ONSHORE_BOUNDARY members of **most3_facts_nc.in**.

In the sample input file fragment shown below, the shoreline is defined as being between an ocean depth of 5 m offshore and a dry land elevation of 0.1 m; that is, MOST will use exclusively wave propagation algorithm for depths greater than 5 m and run-up for elevations greater than 0.1 m.

```

5                'OFFSHORE_BOUNDARY (m)
0.1             'ONSHORE_BOUNDARY (m)
0.0009         'FRIC_COEFF (n**2)
:
:

```

- The maximum wave height specification is used to interrupt calculations if an unphysical wave height is computed.

Typical values are on the order of 40 m. The triggering of the wave maximum condition is typically due to problems with DEM data inputs or errors in run configuration. For more information, see [Troubleshooting Simulations](#).

```

.001           'MIN_WAVE_HEIGHT (m)
5             'OFFSHORE_BOUNDARY (m)
0.1          'ONSHORE_BOUNDARY (m)
0.0009      'FRIC_COEFF (n**2)
1           'OUTER_GRID_RUNUP
50.0      'MAX_WAVE_HEIGHT
90         'GRIDC_TIMESTEP (sec)
30000     'NUM_GRIDC_TIMESTEPS
9         'GRIDA_TIMESTEP_MULTIPLE
3         'GRIDB_TIMESTEP_MULTIPLE
180       'OUTPUT_FREQUENCY
0         'OUTPUT_START
1         'NODE_OUTPUT_FREQ
yakutat_2m_m.asc.s      'GRIDA_DATA
yakutat_24s_m.asc.s    'GRIDB_DATA
yakutat_4s_m.asc.s.s   'GRIDC_DATA
../Sources             'PROP_INPUT_DIR
./                    'OUTPUT_DIR

```



- Values for the onshore Manning coefficient of friction, n can be obtained from a number of sources.
- OUTPUT_FREQUENCY should be a multiple of GRIDA_TIMESTEP_MULTIPLE and GRIDB_TIMESTEP_MULTIPLE. In general, MOST simulations use a "bald earth" approximation, that is, it does not expect to include buildings, trees, and smaller vegetation. These values can be added to MOST DEM data sets, but it is more common to model them with the estimate of the shoreline value of the Manning coefficient of friction.

.001	'MIN_WAVE_HEIGHT (m)
5	'OFFSHORE_BOUNDARY (m)
0.1	'ONSHORE_BOUNDARY (m)
0.0009	'FRIC_COEFF (n**2)
1	'OUTER_GRID_RUNUP
50.0	'MAX_WAVE_HEIGHT
90	'GRIDC_TIMESTEP (sec)
30000	'NUM_GRIDC_TIMESTEPS
9	'GRIDA_TIMESTEP_MULTIPLE
3	'GRIDB_TIMESTEP_MULTIPLE
180	'OUTPUT_FREQUENCY
0	'OUTPUT_START
1	'NODE_OUTPUT_FREQ
yakutat_2m_m.asc.s	'GRIDA_DATA
yakutat_24s_m.asc.s	'GRIDB_DATA
yakutat_4s_m.asc.s.s	'GRIDC_DATA
../Sources	'PROP_INPUT_DIR
./	'OUTPUT_DIR



Sample Inundation Phase Simulation

Given an example command line of:

```
./inundation Yakutat 1946-sources- ./
```

and **most3_facts_nc.in** of the form:

```
0.001          'MIN_WAVE_HEIGHT (m)
5              'OFFSHORE_BOUNDARY (m)
0.1            'ONSHORE_BOUNDARY (m)
0.0009        'FRIC_COEFF (n**2)
1              'OUTER_GRID_RUNUP
50.0           'MAX_WAVE_HEIGHT
90             'GRIDC_Timestep (sec)
30000         'NUM_GRIDC_Timesteps
9              'GRIDA_Timestep_Multiple
3              'GRIDB_Timestep_Multiple
180           'OUTPUT_FREQUENCY
0              'OUTPUT_START
1              'NODE_OUTPUT_FREQ
yakutat_2m_m.asc.s  'GRIDA_DATA
yakutat_24s_m.asc.s 'GRIDB_DATA
yakutat_4s_m.asc.s.s 'GRIDC_DATA
../Sources      'PROP_INPUT_DIR
./              'OUTPUT_DIR
```

As **PARAMETERS_DIR** is **"/**, **inundation** will look for the **most3_facts_nc.in** and the DEM files (**yakutat_2m_m.asc.s**, **yakutat_24s_m.asc.s**, and **yakutat_4s_m.asc.s.s**) in the current directory.

Propagation Phase output will have the prefix **1946-sources-**. The following input files from Propagation Phase (**1946-sources-u.nc**, **1946-sources-v.nc** and **1946-sources-h.nc**) will be located in the **"/Sources"** directory, as specified by the value of **PROP_INPUT_DIR** in **most3_facts_nc.in**.

For historic reasons, the output from **inundation**, the **PROP_INPUT_DIR**, is referred to as DODS URL, and the Propagation Phase output files used as Inundation Phase input are referred to as [FACTS](#) files.

```
DODS URL: ../Sources
Input FACTS files:
zonal U: ../Sources/1946-sources-u.nc
meridional V: ../Sources/1946-sources-v.nc
amplitudes H: ../Sources/1946-sources-h.nc
size of input array: 20 44 1441
```

Similarly, output will be written to the current working directory and will be prefixed with the following string:

"Yakutat": /Yakutat_runup[A|B|C]_[h,v,u]a.nc

In this example, the three input grids have resolutions of 2 arcminutes, 24 arcseconds, and 4 arcseconds, or a ratio of 30:6:1. Runtime information is written to **output_Yakutat.lis**, which contains a runtime stamping, the echoing of initialization, a record of each reading of the input provided by the Propagation Phase, a record of the initial detection of the Propagation Phase wave input, and output events.



MOST Software Manual

```
5-08-2006 18:14:20.000
Site: Yakutat
Input prefix: 1946-
Input Directory: ./
Read Computational parameters: ./most3_facts_nc.in
  Minimum amplitude of input offshore wave (m): 0.001
  Input minimum depth for offshore (m): 5.
  Input "dry land" depth for inundation (m): 0.1
  Input friction coefficient (n**2): 0.0009
  Input runup switch (0 - runup only in gridC, 1 - runup in all grids): 1
  Max allowed eta (m): 30.
  Input time step (sec): 1.
  Input amount of steps: 30000
  Compute "A" arrays every n-th time step, n= 9
  Compute "B" arrays every n-th time step, n= 3
  Input number of steps between snapshots (should be a multiple of A,B
and C time steps) : 180
  ...Starting from: 0
  ...Saving grid every n-th node, n= 1
Reading Bathymetry
  1-ST LEVEL:
Bathymetry: ./yakutat_2m_m.asc.s.sm
  2-ND LEVEL:
Bathymetry: ./yakutat_18s_m.asc.s.c.s
  3-RD LEVEL:
Bathymetry: ./yakutat_4s_m.asc.s.s
  DODS URL: ../Sources
  Input FACTS files:
zonal U: ../Sources/1946-sources-u.nc
meridional V: ../Sources/1946-sources-v.nc
amplitudes H: ../Sources/1946-sources-h.nc
size of input array: 20 44 1441
  Longitude: 217.883367 to 222.950033
  Latitude: 56.04742 to 61.93744
  Time: 0. to 86400.
NetCDF array size for grid C: 181 55
NetCDF array size for grid B: 201 201
NetCDF array size for grid A: 65 68
  output directory: ./
netCDF output: ./Yakutat_runupC_ha.nc
netCDF output: ./Yakutat_runupC_ua.nc
netCDF output: ./Yakutat_runupC_va.nc
netCDF output: ./Yakutat_runupB_ha.nc
netCDF output: ./Yakutat_runupB_ua.nc
netCDF output: ./Yakutat_runupB_va.nc
netCDF output: ./Yakutat_runupA_ha.nc
netCDF output: ./Yakutat_runupA_ua.nc
netCDF output: ./Yakutat_runupA_va.nc
  netCDF initialize
  input 2 is read at t= 60.
```



```
input 3 is read at t= 120.
input 4 is read at t= 180.
.
.
.
input 99 is read at t= 5880.
input 100 wave detected at 5940. amp: -0.12025176cm at 219.2167 ,
58.07674
Initial surface is read at t= 5940.
input 101 is read at t= 6000.
.
.
.
output time step 1 6120.sec
Max/Min elevation values in grid C are: 3.59379193E-11/ -4.28528324E-11
Max/Min elevation values in grid B are: 1.87157639E-07/ -6.17153546E-08
Max/Min elevation values in grid A are: 1.24824416E-05/ -0.00246789331
input 104 is read at t= 6180.
.
.
.
output time step 166 35820.sec
Max/Min elevation values in grid C are: 0.491220241/ -0.283894777
Max/Min elevation values in grid B are: 0.0816834152/ -0.129327379
Max/Min elevation values in grid A are: 0.116327298/ -0.068029162
input 599 is read at t= 35880.
input 600 is read at t= 35940.
Run finished

5-08-2006 18:24:55.000
elapsed secs: 634.429993, user: 633.440002, sys: 0.99000001
clock sec: 635, minutes: 10.583333
```

Inundation Phase Outputs

The Inundation Phase produces one log file and nine data output files. The data output files are organized in three groups of three files:

- The time-stepped wave evolution information for each of the nested input grids (Grid A, Grid B, and Grid C) is saved in its own set of output files.
- Each set of output files consists of the three [netCDF](#)-formatted files containing the components of the time-stepped tsunami solution state in wave height, zonal velocity, and meridional velocity.

Both the Propagation Phase log file and the data output files are written to a directory specified by **most3_facts_nc.in**. The base for the filenames is the value of the first (**OUTPUT_PREFIX**) command line argument supplied to **inundation**. The full value of the log file name is obtained by prepending the string "**Output_**" to the base name and appending the extension ".**lis**". The base name of each data file has a tag of the form **_runup[A|B|C]** appended to it, to indicate the grid that produced the data, and a suffix indicating the wave component [**ha.nc|ua.nc|va.nc**] contained.



In the case of a command line of the form (with the OUTPUT_PREFIX argument in **bold**):

```
./inundation Yakutat 1946-sources- ./
```

where **most3_facts_nc.in** contains the following:

```
0.001          'MIN_WAVE_HEIGHT (m)
5              'OFFSHORE_BOUNDARY (m)
0.1            'ONSHORE_BOUNDARY (m)
0.0009        'FRIC_COEFF (n**2)
1              'OUTER_GRID_RUNUP
300.0          'MAX_WAVE_HEIGHT
90             'GRIDC_Timestep (sec)
30000         'NUM_GRIDC_Timesteps
9              'GRIDA_Timestep_Multiple
3              'GRIDB_Timestep_Multiple
180           'OUTPUT_FREQUENCY
0              'OUTPUT_START
1              'NODE_OUTPUT_FREQ
yakutat_2m_m.asc.s      'GRIDA_DATA
yakutat_24s_m.asc.s    'GRIDB_DATA
yakutat_4s_m.asc.s.s   'GRIDC_DATA
./                  'PROP_INPUT_DIR
/~/SimulationData/    'OUTPUT_DIR
```

The log is written to **/Home/SimulationData/Output_Yakutat.lis**, and the [netCDF](#) files containing wave propagation data is written to the nine files defined by **/Home/SimulationData/Yakutat_runup[A|B|C]_[h,v,u]a.nc**. For more information on the **inundation** log files, see [inundation Command Outputs](#). For more information on tsunami wave output files, see [Wave Evolution File Formats](#).



Reference Guide

This section provides reference information about the input values and data required by each MOST executable and the format of MOST input and output data files.

Executables

MOST installations provide the following executables:

- **deform** Computes ocean surface height changes that occur due to ocean bottom deformation as a result of a rupture along a submerged rectangular fault.
- **propagation** Generates a time-stepped series of wave height and velocity across the open ocean using a finite difference algorithm.
- **inundation** Generates a time-stepped series of wave height and velocity, including run-up, for a shoreline using nested grids and a finite difference algorithm.
- **bath_sample** Tool to allow the re-gridding of files that contain a grid of bathymetric information, and to allow resizing and subset selection.
- **bath_corr** Tool to correct potentially problematic features in the bathymetric data, such as excessively steep changes, single-node islands, and discontinuities of bathymetric data.

deform

Computes ocean surface height changes on an input DEM grid that occurs due to ocean bottom deformation as a result of a rupture along a submerged rectangular fault.

deform Restrictions

The **deform** executable is restricted to bathymetric grids less than or equal to 2581 nodes of latitude (North/South) by 2063 nodes of longitude (East/West).

deform Command Inputs

The **deform** executable obtains command inputs from *stdin* and from the file **static.dat**.

Standard Input

The **deform** executable obtains command inputs from *stdin*, which can be provided interactively or by input redirection. A typical input file redirected into *stdin* might look like the following:

```
topo4edge.corr        'BATHYMETRIC_FILE
150,150                'X_NODES, Y_NODES
287.2735              'LONGITUDE (deg):
-35.69531             'LATITUDE (deg):
100                    'LENGTH (KM):
50                     'WIDTH (KM):
18                     'DIP (DEG):
90                     'RAKE (DEG):
19                     'STRIKE (DEG):
1                      'SLIP (M)', U0
5                      'DEPTH (KM):', HTOP
```



Note that an input file passed to *stdin* for **deform** should have no tabs, only spaces.

BATHYMETRIC_FILE		
A string containing the path of a DEM information input file.		
	FORMAT	CHARACTER*80
	USAGE	<p>Maximum Length: 80 Characters</p> <p>DEM input files are currently limited to grids of no more than 2581 nodes of latitude (North/South) by 2063 nodes of longitude (East/West).</p> <p>The prefix may be relative or absolute, but must not contain environment variables or wildcard/globbering patterns such as: ". ./", ". /", or "~ /".</p>

X_NODES, Y_NODES		
The extent of the target subsection of the DEM grid.		
	FORMAT	INTEGER, INTEGER (Two integers separated by a comma or space.)
	USAGE	<p>Maximum Value: 500x500</p> <p>Typical Value: 300</p> <p>The ocean floor disturbance contained in the run's deformation rectangle is mapped to the ocean surface within the subsection defined by these data.</p>

LONGITUDE		
The longitude of the center of the down-dip side of the deformation rectangle.		
	FORMAT	REAL*8
	USAGE	<p>Measured in decimal degrees.</p> <p>The value of LONGITUDE must be a valid longitude within the bathymetric grid defined in BATHYMETRIC_FILE. Supports both the 360° and the ±180° reference systems.</p>

LATITUDE		
The latitude of the center of the down-dip side of the deformation rectangle.		
	FORMAT	REAL*8
	USAGE	<p>Measured in decimal degrees.</p> <p>The value of LATITUDE must be a valid latitude within the bathymetric grid defined in BATHYMETRIC_FILE.</p>



LENGTH		
The X axis of the rectangle. If the strike angle of the fault is zero, this axis runs north/south.		
	FORMAT	REAL*8
	USAGE	Measured in kilometers. Typical Value: 200 Km Must be contained within the limits of the bathymetric grid.

WIDTH		
The Y axis of the rectangle. If the strike angle of the fault is zero, this axis runs east/west.		
	FORMAT	REAL*8
	USAGE	Measured in kilometers. Typical Value: 100 Km Must be contained within the limits of the bathymetric grid.

DIP		
The angle between a horizontal plane representing the local Earth surface and the local fault plane. (See Figure 4.)		
	FORMAT	REAL*8
	USAGE	Measured in degrees. Typical Value: 13°

RAKE		
The angle between the slip direction along the fault and the local Earth surface. Rake angles are considered positive counterclockwise and negative clockwise. (See Figure 4.)		
	FORMAT	REAL*8
	USAGE	Measured in degrees. Typical Value: 90° The RAKE angle is also known as the slip angle.

STRIKE		
The angle between the local fault trace and geographic North measured in 0°-360°. (See Figure 4.)		
	FORMAT	REAL*8



	USAGE	Measured in degrees. Typical Value: 180°
--	--------------	---

SLIP_MAGNITUDE		
The magnitude of displacement along a fault during a seismic event.		
	FORMAT	REAL*8
	USAGE	Measured in meters. Typical Value: 5 m The Propagation Phase executable, propagation , multiplies this value of SLIP_MAGNITUDE by the value of SLIP_MAGNITUDE_SCALE_FACTOR that is obtained from its own input to define the magnitude of the fault slip that is actually used in calculating tsunami wave propagation.

DEPTH		
The depth below sea level of the epicenter, or origin, of the tsunami-generating seismic event.		
	FORMAT	REAL*8
	USAGE	Measured in kilometers. Typical Value: 5 Km

static.dat

Contains a list of parameters used in integrating the effect of the ocean floor changes defined by a deformation rectangle over the DEM sub-grid specified. The data in **static.dat** should be treated as read-only, and its contents are:

```

41      'X_INTEGRATION_DIMENSION
21      'X_INTEGRATION_DIMENSION
8.11   'P_WAVE_VELOCITY
4.49   ' P_WAVE_VELOCITY

```

deform Command Outputs

The **deform** executable writes its command output to **stdout**. Below is sample output from a run using a redirected input file (**deform.in**) that contains the following values:

```

topo4edge.corr      'BATHYMETRIC_FILE
150,150             'X_NODES, Y_NODES
287.2735            'LONGITUDE (deg):
-35.69531           'LATITUDE (deg):
100                 'LENGTH (KM):
50                  'WIDTH (KM):
18                  'DIP (DEG):
90                  'RAKE (DEG):
19                  'STRIKE (DEG):

```



```
1          'SLIP (M) ',U0  
5          'DEPTH (KM) : ',HTOP
```

The output primarily echoes the input from *stdin* and *static.dat*. Note that the pair of numbers written to the third line above the bottom (shown here in **bold**) is an artifact of program development and should be ignored.



```
Bathymetry filename:  indo_lrg.corr
Input size of the source array
x-nodes (<500),y-nodes (<500):  150 150
Coordinates of the source center:
Longitude, E (deg):
  87.2735
Latitude, N (deg):
-15.69531
STATIC is working
Length (km):
  100.
Width (km):
  50.
DIP (deg):
  18.
SLIP (deg):
  90.
STRIKE (deg):
  19.
SLIP AMOUNT (m)
  1.
DEPTH (km):
  5.
528.648315  534.382751
Integration area 41  x 21
Writing results
```

deform Data Inputs

One data input file is required by **deform**.

DEM DATA FILE	
	<p>File specified by the BATHYMETRIC_FILE command input and containing DEM data in the MOST DEM file format.</p> <p>DEM input files for deform are currently limited to grids of no more than 2581 finite difference nodes of latitude (North/South) by 2063 finite difference nodes of longitude (East/West).</p> <p>Any Propagation Phase simulation using the output of deform must also use this DEM file as input. For more information about the DEM file format, see DEM Data File Format.</p>



deform Data Outputs

One data output file is produced by **deform**.

deform.dat	
	File name deform.dat contains ocean surface-level variations due to ocean floor changes in the deformation rectangle mapped to a subsection of nodes of the input DEM (BATHYMETRIC_FILE). The dimensions of the subsection are determined by the X_NODES, Y_NODES command input values. The location of the subsection centered around the epicenter is written into deform.dat .
	The deform executable overwrites any existing deform.dat file.
	For more information about the deform.dat file format, see Deformation Output File Format .

propagation

The Propagation Phase executable propagates a tsunami on the open ocean by solving depth-integrated [NSW](#) wave equations in 2 spatial + 1 temporal dimensions. The inputs to **propagation** are a finite difference grid of DEM data for the ocean region the tsunami is to traverse, and the output from one or more runs of the **deform** executable. The output of the Propagation Phase is the three components (wave height, zonal velocity, and meridional velocity) of the solution to the system of NSW equations for selected time steps.

propagation Command Inputs

The **propagation** executable obtains command inputs from *stdin*.

Standard Input

The **propagation** executable obtains command inputs from *stdin*, which can be provided interactively or by input redirection. A typical input file redirected into *stdin* might look like the following:

```
10          'MIN_DEPTH_THRESH (M)
10          'Timestep (SEC)
3600        'NUMBER_OF_TIMESTEPS
6           'OUTPUT_FREQUENCY
12          'OUTPUT_START
indo2min.corr2  'BATHYMETRIC_FILE
3           'NUM_DEFORMATION INPUTS
src1_lg.dat   'DEFORMATION INPUT_FILE
20.         'SLIP_MAGNITUDE_SCALE_FACTOR (M)
src2_lg.dat   'DEFORMATION INPUT_FILE
20.         'SLIP_MAGNITUDE_SCALE_FACTOR (M)
src3_lg.dat   'DEFORMATION INPUT_FILE
20.         'SLIP_MAGNITUDE_SCALE_FACTOR (M)
out/indo2min  '<OUTPUT_PREFIX>
```

Note that an input file passed to *stdin* for **propagation** should have no tabs, only spaces.

MIN_DEPTH_THRESH
Provides the minimum depth as a boundary value for Propagation Phase calculations.



	FORMAT	REAL*8
	USAGE	<p>Measured in meters.</p> <p>Typical Value: <u>20 m</u></p> <p>The MIN_DEPTH_THRESH defines shallow water cutoff depth to be used in Propagation Phase calculations.</p>

<u>TIMESTEP</u>		
Size of time steps used to calculate wave propagation.		
	FORMAT	REAL*8
	USAGE	<p>Measured in seconds.</p> <p>Typical Value: 1 second</p> <p>The choice of TIMESTEP must be consistent with the Courant, Friedrichs, and Lewy stability condition and may vary significantly from the value provided above depending on grid spacing. The maximum stable time step for a given set of DEM inputs can be obtained from bath_corr. For more information, see bath_corr. For more information on choosing an appropriate time step value, see Running propagation.</p>

<u>NUMBER_OF_TIMESTEPS</u>		
Number of time steps in a Propagation Phase calculation.		
	FORMAT	INTEGER
	USAGE	Typical Value: 25000

<u>OUTPUT_FREQUENCY</u>		
Frequency with which the state of the propagated tsunami wave is saved to disk.		
	FORMAT	INTEGER
	USAGE	<p>Typical Value: 100</p> <p>The value of OUTPUT_FREQUENCY is expressed in units of TIMESTEP.</p> <p>The propagation executable saves the tsunami wave state every OUTPUT_FREQUENCY time steps.</p>

<u>OUTPUT_START</u>		
Identifies the first time step that propagation writes out the propagated tsunami wave state.		
	FORMAT	INTEGER



	USAGE	<p>Typical Value: 1</p> <p>The propagation executable begins writing out the tsunami wave state on the OUTPUT_STARTth time step.</p>
--	--------------	--

BATHYMETRIC_FILE		
A string containing the path of a DEM data file.		
	FORMAT	CHARACTER*80
	USAGE	<p>Maximum Length: 80 Characters</p> <p>The propagation executable can use data grids of any size. The DEM data in the file must be the same as that used to generate the Deformation Phase outputs (DEFORMATION_FILE), as these data are used as inputs to propagation. The prefix may be relative or absolute, but must not contain environment variables or wildcard/globbing patterns such as: ". ./", ". /", or "~ /".</p>

NUM_DEFORMATIONS		
The number of inputs from the Deformation Phase.		
	FORMAT	INTEGER
	USAGE	<p>Minimum Value: 1</p> <p>Each input file is generated by a single run of deform using the same DEM data file and a unique deformation rectangle.</p> <p>The propagation executable prompts for NUM_DEFORMATIONS, the Deformation Phase inputs, requesting a SLIP_MAGNITUDE_SCALE_FACTOR and a DEFORMATION_FILE for each input.</p> <p>For example, in the sample input file above, NUM_DEFORMATIONS equals three, and three Deformation Phase output files, each with a specific SLIP_MAGNITUDE_SCALE_FACTOR, are provided.</p>

There are NUM_DEFORMATIONS instances for the next two inputs.

DEFORMATION_FILE		
A string containing the path of a Deformation Phase output file.		
	FORMAT	CHARACTER*80
	USAGE	<p>The file must have been generated from a deform run that used the same DEM data as the current Propagation Phase run to generate Deformation Phase data.</p> <p>The path may be relative or absolute, but must not contain environment variables or wildcard/globbing patterns such as: ". ./", ". /", or "~ /".</p>



SLIP_MAGNITUDE_SCALE_FACTOR		
The scaling factor applied to the SLIP_MAGNITUDE.		
	FORMAT	REAL*8
	USAGE	<p>Typical Value: 1</p> <p>The Propagation Phase executable, propagation, scales (multiplies) the value of SLIP_MAGNITUDE supplied to deform and stores it in the DEFORMATION_FILE, by this instance of SLIP_MAGNITUDE_SCALE_FACTOR, to define the actual magnitude of the fault slip that is used in calculating tsunami wave propagation. This magnitude will multiply the slip value used in the deformation phase computations, if the final slip amount has previously been specified in to deform, the value of the scale factor should then be 1.</p>

<OUTPUT_PREFIX>		
String containing the path prefix for all files that are output from the current Propagation Phase run.		
	FORMAT	CHARACTER*80
	USAGE	<p>Three netCDF output files are created with names having the form:</p> <p><OUTPUT_PREFIX>.ha.nc—the wave height in centimeters at each saved time step.</p> <p><OUTPUT_PREFIX>.va.nc—the meridional velocity in centimeters per second at each saved time step.</p> <p><OUTPUT_PREFIX>.ua.nc—the zonal velocity in centimeters per second at each saved time step.</p> <p>For example, if the <OUTPUT_PREFIX> is specified as <code>out/indo2min.nc</code>, propagation writes indo2min.ha.nc, indo2min.va.nc, and indo2min.ua.nc to the subdirectory <code>out</code>.</p> <p>The prefix may be relative or absolute, but must not contain environment variables or wildcard/globbering patterns such as: <code>"/"</code>, <code>"/"</code>, or <code>"/"</code>. Note that any characters appearing after a "." (period) are assumed to be a file suffix and are ignored. For example, if <OUTPUT_PREFIX> is specified as seattle.out, the ".out" suffix is dropped and outputs are written to seattle.ha.nc, seattle.va.nc, and seattle.ua.nc.</p>

propagation Command Outputs

The **propagation** executable writes command output to *stdout*.



Below is an extract of sample output for a redirected input file (**indo2min.in**) specifying a ten-hour run, using initial conditions derived from three deformation rectangles, saving its state every six time steps, starting with time step twelve. The redirected input file has the following values:

```
10          'MIN_DEPTH_THRESH (M)
10          'Timestep (SEC)
3600        'NUMBER_OF_TIMESTEPS
6           'OUTPUT_FREQUENCY
12          'OUTPUT_START
indo2min.corr2  'BATHYMETRIC_FILE
3           'NUM_DEFORMATION INPUTS
src1_lg.dat   'DEFORMATION INPUT_FILE
20.         'SLIP_MAGNITUDE_SCALE_FACTOR (M)
src2_lg.dat   'DEFORMATION INPUT_FILE
20.         'SLIP_MAGNITUDE_SCALE_FACTOR (M)
src3_lg.dat   'DEFORMATION INPUT_FILE
20.         'SLIP_MAGNITUDE_SCALE_FACTOR (M)
out/indo2min  '<OUTPUT_PREFIX>
```

Input data is echoed to *stdout*. Only the location of the last deformation rectangle and the name of one of the three data output files are written to *stdout*. This has no effect on the program's execution.

```
propagation < indo2min.in
Input minimum depth for offshore (m):  10.
Input time step (sec):  10.
Input amount of steps:  3600
Input number of steps between snapshots:  12
...Starting from:  6
Reading Bathymetry
Bathymetry filename:  longitude:  35.01667  120.0167
latitude:  -35.00977  25.04535
Input number of fault-planes:
FAULT 1  Input filename:          Input slip(m)
FAULT 2  Input filename:          Input slip(m)
FAULT 3  Input filename:          Input slip(m)
source location:  93.4722977  11.6049995
netCDF file prefix:  *indo2min*
*
indo2min_ha.nc *
dimensions: 1276 950
netCDF initialization complete
time step 1 time =  10.sec
time step 2 time =  20.sec
time step 3 time =  30.sec
.
.
.
time step 3600 time =  36000.sec
output time step 6000
end mostl_db
```



propagation Data Inputs

Propagation Phase runs using **propagation** require NUM_DEFORMATIONS + 1 data inputs: one DEM data file and the output from the NUM_DEFORMATIONS Deformation Phase runs.

DEM DATA FILE	
	File specified by the BATHYMETRIC_FILE command input and containing DEM data in the MOST DEM file format. DEM input files for propagation are currently limited to grids of no more than 2551 nodes of latitude (North/South) by 1900 nodes of longitude (East/West). The DEM data in this file must be the same as that used to produce the Deformation Phase outputs that propagation uses as inputs. For more information about the MOST DEM file format, see DEM Data File Format .

DEFORMATION_FILE	
	A file containing ocean surface-level variation caused by ocean floor changes and mapped to a subsection of nodes of the input DEM file (BATHYMETRIC_FILE). For more information about the deform.dat file format, see Deformation Output File Format .

propagation Data Outputs

The Propagation Phase saves the solution to the [NSW](#) equations every OUTPUT_FREQUENCY time steps by writing each of the solution's three components of this solution (wave height, zonal velocity, and meridional velocity) to its own file.

<OUTPUT_PREFIX>_ha.nc	
	A file in netCDF format containing wave height of the tsunami at every point on the bathymetric grid. The data is first saved at time step OUTPUT_START and then at every OUTPUT_FREQUENCY time step thereafter. Wave height is measured in centimeters along the perpendicular away from the center of the Earth and as positive above mean sea level. The output name of the file is <OUTPUT_PREFIX> with the string "_ha.nc" appended. For more information, see Wave Height File Format .

<OUTPUT_PREFIX>_va.nc	
	A file in netCDF format containing the meridional velocity of the tsunami at every 4 th point on the bathymetric grid. The data is first saved at time step OUTPUT_START and then at every OUTPUT_FREQUENCY time step thereafter. The meridional velocity is measured in centimeters per second parallel to lines of constant longitude and is positive in the North direction. The output name of the file is <OUTPUT_PREFIX> with the string "_va.nc" appended. For more information, see Meridional Velocity File Format .



<OUTPUT_PREFIX>_ua.nc	
	<p>A file in netCDF format containing the zonal velocity of the tsunami at every point on the bathymetric grid. The data is first saved at time step OUTPUT_START and then at every OUTPUT_FREQUENCY time step thereafter.</p> <p>The zonal velocity is measured in centimeters per second parallel to lines of constant latitude and is positive in the East direction. The output name of the file is <OUTPUT_PREFIX> with the string "_ua.nc" appended. For more information, see Zonal Velocity File Format.</p>

inundation

The Inundation Phase executable extends the tsunami propagation provided by the Propagation Phase to the shoreline, using the output of **propagation** as a boundary condition and initial condition. A calculation on [NSW](#) wave equations in 2 spatial + 1 temporal dimensions is performed over a set of three nested grids: Grid A, Grid B, and Grid C. Beginning with Grid A, which has the largest size and coarsest resolution, each successive grid has a finer resolution and covers a smaller area. To model the inundation of shore, a [run-up](#) algorithm is applied on the innermost grid, Grid C. As an option, it may also be applied to Grid A and Grid B.

The inputs to **inundation** are the finite difference DEM information for each of the nested grids the program will process, and the output from the Propagation Phase containing the three components (wave height, zonal velocity, and meridional velocity) of the propagation wave solution for selected time steps. It is recommended that simulation runs using **inundation** contain depths of at least 1000 meters along the wave front modeled by **propagation**.

The Inundation Phase produces output for each of the nested grids used in the simulation. For each grid, the three components of the solution to the system of NSW equations are saved for selected time steps.

inundation Restrictions

All three grids of DEM data used by **inundation**—Grid A, Grid B, and Grid C—are restricted to being less than or equal to 2000 nodes of latitude (North/South) by 2000 nodes of longitude (East/West). For more information on selecting proper bathymetric grids, see [Constructing DEM Data Sets](#).

Shoreline tsunami simulations using **inundation** do not explicitly include tidal dynamics. Instead, tides are assumed to interact linearly with a propagating tsunami wave. The topography used by **inundation** does not include buildings, trees, and smaller vegetation.

inundation Command Inputs

The **inundation** executable obtains command inputs from the command line and from the input file **most3_facts_nc.in**.

Command Line Arguments

The **inundation** executable requires three command line arguments with a syntax of:

```
inundation <OUTPUT_PREFIX> <INPUT_DATAFILE_BASENAME> <PARAMETERS_DIR>
```

Where:



MOST Software Manual

<OUTPUT_PREFIX>		
String containing the path prefix for all output files of the current Inundation Phase run.		
	FORMAT	CHARACTER*80



	USAGE	<p>The output files are written to the OUTPUT_DIR directory that is specified in most3_facts_nc.in; therefore, <OUTPUT_PREFIX> should contain no pathing.</p> <p>Nine output files are created using the value of <OUTPUT_PREFIX>:</p> <ul style="list-style-type: none">• A run log is written to output_<OUTPUT_PREFIX>.lis.• Three netCDF output files are created for each of the nested grids used in an Inundation Phase simulation, each with a prefix defined by the <OUTPUT_PREFIX> command line argument. <p>The general form of the file names is: <OUTPUT_PREFIX> + "_run-up" + {"A","B","C"} + {"_ha","_va","_ua"}</p> <p>For Grid A, the file names are of the form:</p> <ul style="list-style-type: none">• <OUTPUT_PREFIX>_run-upA_ha.nc with each saved time step's wave height measured in centimeters in Grid A.• <OUTPUT_PREFIX>_run-upA_va.nc with each saved time step's meridional velocity measured in centimeters per second in Grid A.• <OUTPUT_PREFIX>_run-upA_ua.nc with each saved time step's zonal velocity measured in centimeters per second in Grid A. <p>For Grid B, the file names are of the form:</p> <ul style="list-style-type: none">• <OUTPUT_PREFIX>_run-upB_ha.nc with each saved time step's wave height measured in centimeters in Grid B.• <OUTPUT_PREFIX>_run-upB_va.nc with each saved time step's meridional velocity measured in centimeters per second in Grid B.• <OUTPUT_PREFIX>_run-upB_ua.nc with each saved time step's zonal velocity measured in centimeters per second in Grid B. <p>For Grid C, the file names are of the form:</p> <ul style="list-style-type: none">• <OUTPUT_PREFIX>_run-upC_ha.nc with each saved time step's wave height measured in centimeters in Grid C.• <OUTPUT_PREFIX>_run-upC_va.nc with each saved time step's meridional velocity measured in centimeters per second in Grid C.• <OUTPUT_PREFIX>_run-upC_ua.nc with each saved time step's zonal velocity measured in centimeters per second in Grid C. <p>For example, given a command line of the form: <i>./inundation India in/indo2min.nc ../Params</i></p> <p>The run log is found in the current working directory in a file named output_india.lis and the Grid B output is found in the files India_run-upB_ha.nc, India_run-upB_va.nc, and India_run-upB_ua.nc.</p>
--	--------------	---



<INPUT_DATAFILE_BASENAME>		
String containing the path prefix for Propagation Phase inputs to the current Inundation Phase run.		
	FORMAT	CHARACTER*80
	USAGE	<p>Data from the Propagation Phase are read from the directory PROP_INPUT_DIR that is specified in most3_facts_nc.in; therefore, <INPUT_DATAFILE_BASENAME> should contain no pathing.</p> <p>Three netCDF files previously created by propagation are used as inputs, and their names must be of the form <INPUT_DATAFILE_BASENAME> + {h,v,u}.nc:</p> <ul style="list-style-type: none"> • <INPUT_DATAFILE_BASENAME>h.nc with each saved time step's wave height. • <INPUT_DATAFILE_BASENAME>v.nc with each saved time step's meridional velocity. • <INPUT_DATAFILE_BASENAME>u.nc with each saved time step's zonal velocity. <p>For example, given a command line of the form: <i>./inundation India indo2min ../Params</i></p> <p>The inundation executable attempts to read indo2min_ha.nc, indo2min_va.nc, and indo2min_ua.nc from the sub-directory in.</p>

<PARAMETERS_DIR>		
String containing the path to the directory that contains the inundation command input file most3_facts_nc.in and the DEM data for each of the three grids that inundation will process.		
	FORMAT	CHARACTER*8
	USAGE	<p>The prefix may be relative or absolute, and may contain environment variables or wildcard/globbing patterns such as: "../", "./", or "~/". The name of a grid's input DEM file is set by the GRIDA_FILE, GRIDB_FILE, and GRIDC_FILE arguments in the most3_facts_nc.in input file.</p> <p>Given a command line of the form: <i>./inundation India indo2min ../Param</i></p> <p>The inundation executable attempts to use ../Param/most3_facts_nc.in as command input. The executable also opens ../Param/GRIDA_FILE, ../Param/GRIDB_FILE, and ../Param/GRIDC_FILE for DEM input.</p>



most3_facts_nc.in

The **inundation** executable is invoked with a command line of the form:

```
inundation <OUTPUT_PREFIX> <INPUT_DATAFILE_BASENAME>
<PARAMETERS_DIR>
```

The **inundation** executable obtains most command inputs from the file **PARAMETERS_DIR/most3_facts_nc.in**. The file **most3_facts_nc.in** must be in the same directory as the DEM inputs. A typical example of **most3_facts_nc.in** might be:

```
0.001           'MIN_WAVE_HEIGHT (m)
5              'OFFSHORE_BOUNDARY (m)
0.1            'ONSHORE_BOUNDARY (m)
0.0009        'FRIC_COEFF (n**2)
1              'OUTER_GRID_RUNUP
300.0         'MAX_WAVE_HEIGHT
.90           'GRIDC_TIMESTEP (sec)
30000        'NUM_GRIDC_TIMESTEPS
9             'GRIDA_TIMESTEP_MULTIPLE
3            'GRIDB_TIMESTEP_MULTIPLE
180          'OUTPUT_FREQUENCY
0            'OUTPUT_START
1           'NODE_OUTPUT_FREQ
yakutat_2m_m.asc.s  'GRIDA_DATA
yakutat_24s_m.asc.s 'GRIDB_DATA
yakutat_4s_m.asc.s.s 'GRIDC_DATA
./          'PROP_INPUT_DIR
./          'OUTPUT_DIR
```

Note that versions of **most3_facts_nc.in** for **inundation** should have no tabs, only spaces.

MIN_WAVE_HEIGHT		
Specifies the minimum amplitude of an offshore wave that defines the presence of a tsunami.		
	FORMAT	REAL*8
	USAGE	<p>Measured in meters.</p> <p>Typical Value:0.001 m</p> <p>MIN_WAVE_HEIGHT is the threshold value used to determine when to start computing wave propagation based on input data from the Propagation Phase.</p> <p>Wave heights on the boundary of the coarsest and largest grid are read from input supplied by the Propagation Phase and are ignored if the incoming wave has a value smaller than MIN_WAVE_HEIGHT.</p>
OFFSHORE_BOUNDARY		
The minimum depth for offshore calculations.		
	FORMAT	REAL*8



	USAGE	<p>Typical Value: 5 m</p> <p>Depth is treated as positive definite, measured downward from mean sea level. OFFSHORE_BOUNDARY is the threshold value that defines the location of a reflective boundary in grids A and B. For depths greater than this value, the wave propagation algorithm without run-up is used. The values of OFFSHORE_BOUNDARY and ONSHORE_BOUNDARY should not be the same, to allow proper boundary matching.</p>
--	--------------	---

ONSHORE_BOUNDARY		
The maximum depth for onshore calculations.		
	FORMAT	REAL*8
	USAGE	<p>Measured in meters.</p> <p>Typical Value: 0.1 m</p> <p>Depth is treated as positive definite, measured from mean sea level; areas above sea level are treated as negative.</p> <p>ONSHORE_BOUNDARY is the threshold value that defines the computational boundary between water and dry land for the run-up algorithm used in inundation. For depths less than this value, a run-up algorithm is used to augment the wave propagation algorithm of inundation. The values of OFFSHORE_BOUNDARY and ONSHORE_BOUNDARY should not be the same, to allow proper boundary matching.</p>

FRIC_COEFF		
The value of the dimensionless Manning roughness coefficient squared for the shoreline.		
	FORMAT	REAL*8
	USAGE	<p>Typical Value: 0.0009</p> <p>The Manning formula is an empirical formula for open-channel flow that can be applied to shoreline run-up and is parameterized by surface roughness and the Manning coefficient.</p>

OUTER_GRID_RUNUP		
Logical flag that controls whether the run-up algorithm is applied to the outer as well as the inner grids used by inundation .		
	FORMAT	INTEGER



	USAGE	OUTER_GRID_RUNUP Value	Result
		0	Run-up is calculated for the innermost grid used by inundation .
		1	Run-up is calculated for all grids used by inundation .

MAX_WAVE_HEIGHT		
Maximum wave height permitted in an Inundation Phase calculation.		
	FORMAT	REAL*8
	USAGE	<p>Measured in meters.</p> <p>Typical Value: 50 m</p> <p>Defines a maximum value of the height of a simulated tsunami striking a shoreline. This parameter is used to identify and terminate unstable runs. If exceeded, the program aborts with an error message.</p>

GRIDC_TIMESTEP		
Size of time steps used to calculate wave propagation on the innermost, finest-resolution grid.		
	FORMAT	REAL*8
	USAGE	<p>Measured in seconds.</p> <p>Typical Value: 0.2 seconds</p> <p>The choice of GRIDC_TIMESTEP must satisfy the Courant, Friedrichs, and Lewy stability condition for finite difference wave equations for this grid. The maximum stable time step should be obtained for a given set of DEM inputs from bath_corr. For more information, see bath_corr. For more information on choosing an appropriate time step value, see Running inundation.</p>

NUM_OF_GRIDC_TIMESTEP		
Number of time steps in an Inundation Phase calculation on the innermost, finest-resolution grid.		
	FORMAT	INTEGER
	USAGE	Typical Value: 10000

GRIDA_TIMESTEP_MULTIPLE		
Frequency of the finite difference calculation performed on the outer, coarsest, and largest grid (Grid A), specified as a multiple Grid C time step.		



	FORMAT	INTEGER
	USAGE	<p>The value of GRIDA_Timestep_MULTIPLE is expressed in terms of number of computations on Grid C for Grid A computation, representing the number of GRIDC_TimestepS between wave equation update calculations that are to be performed on Grid A.</p> <p>The choice of GRIDA_Timestep_MULTIPLE must satisfy the Courant, Friedrichs, and Lewy stability condition for finite difference wave equations for this grid, which should be obtained from the grid's DEM input data by using bath_corr. For more information, see bath_corr.</p> <p>The value of GRIDA_Timestep_MULTIPLE must be such that $\text{GRIDA_Timestep_MULTIPLE} \times \text{GRIDC_Timestep}$ is smaller than the max dt returned by bath_corr for Grid A.</p>

GRIDB_Timestep_MULTIPLE		
Frequency of the finite difference calculation performed on the intermediate grid (Grid B), specified as a multiple Grid C time step.		
	FORMAT	INTEGER
	USAGE	<p>The value of GRIDB_Timestep_MULTIPLE is expressed in terms of number of computations on Grid C for Grid B computation, representing the number of GRIDC_TimestepS between wave equation update calculations that are to be performed on Grid B.</p> <p>The choice of GRIDB_Timestep_MULTIPLE must satisfy the Courant, Friedrichs, and Lewy stability condition for finite difference wave equations for this grid, which should be obtained from the grid's DEM input data by using bath_corr. For more information, see Using bath_corr.</p> <p>The value of GRIDB_Timestep_MULTIPLE must be such that $\text{GRIDB_Timestep_MULTIPLE} \times \text{GRIDC_Timestep}$ is smaller than the max dt returned by bath_corr for Grid B.</p>

OUTPUT_FREQUENCY		
Frequency with which the state of the propagated tsunami wave is saved to disk.		
	FORMAT	INTEGER



	USAGE	<p>Typical Value: 20</p> <p>The value of OUTPUT_FREQUENCY is expressed in units of GRIDC_TIMESTEP, representing the number of GRIDC_TIMESTEPS between each write of the tsunami state, on all grids, to disk. The value of OUTPUT_FREQUENCY must be a multiple of both GRIDA_TIMESTEP_MULTIPLE and GRIDB_TIMESTEP_MULTIPLE.</p>
--	--------------	---

OUTPUT_START		
Identifies the first time step at which inundation writes out the propagated tsunami wave state.		
	FORMAT	INTEGER
	USAGE	<p>Typical Value: 1</p> <p>The value of OUTPUT_START is expressed in units of GRIDC_TIMESTEP. The inundation executable begins writing out the tsunami wave state on the OUTPUT_STARTth time step. The value of OUTPUT_START must be a multiple of both GRIDA_TIMESTEP_MULTIPLE and GRIDB_TIMESTEP_MULTIPLE.</p>

NODE_OUTPUT_FREQ		
Nodes to skip in saving to output.		
	FORMAT	INTEGER
	USAGE	<p>NODE_OUTPUT_FREQ controls the spatial resolution of the output file by specifying the density of nodes to be stored in an output file: every NODE_OUTPUT_FREQth node is written to the output. For example, if NODE_OUTPUT_FREQ is set to one, then every computational node's value is written to output; if the value is two, every second node's value is written to output. NODE_OUTPUT_FREQ applies to the nodes of all grids.</p>

GRIDA_DATA		
A string containing the name of a DEM data file for Grid A, the grid with the largest size and coarsest resolution.		
	FORMAT	CHARACTER*80
	USAGE	The path to the file specified by GRIDA_DATA is controlled by the value of <PARAMETERS_DIR>.

GRIDB_DATA		
A string containing the name of a DEM data file for Grid B, the grid with intermediate size and resolution.		
	FORMAT	CHARACTER*80



	USAGE	The path to the file specified by GRIDB_DATA is controlled by the value of <PARAMETERS_DIR>.
--	--------------	--

GRIDC_DATA		
A string containing the name of a DEM data file for Grid C, the grid with the finest resolution.		
	FORMAT	CHARACTER*80
	USAGE	The path to the file specified by GRIDC_DATA is controlled by the value of <PARAMETERS_DIR>.

PROP_INPUT_DIR

Path to a directory containing the output from a Propagation Phase simulation to be used as input to **inundation**.

FORMAT	CHARACTER*80
USAGE	The prefix may be relative or absolute, and may contain relative path specifications of the form ". ./" and ". /", but must not contain environment variables or globbing patterns such as "~ /" or <i>\$HOME</i> .

OUTPUT_DIR		
Path to a directory where output will be stored.		
	FORMAT	CHARACTER*80
	USAGE	The prefix may be relative or absolute, and may contain special relative path specifications of the form ". ./" and ". /", but must not contain environment variables or globbing patterns such as "~ /" or <i>\$HOME</i> .

inundation Command Outputs

The **inundation** executable writes command output to the file **OUTPUT_DIR/output_<OUTPUT_PREFIX>.lis**. Below is example output for a command line of:

```
./inundation Yakutat 1946-sources- ./
```

where the **most3_facts_nc.in** contains the following:

```
0.001          'MIN_WAVE_HEIGHT (m)
5              'OFFSHORE_BOUNDARY (m)
0.1           'ONSHORE_BOUNDARY (m)
0.0009        'FRIC_COEFF (n**2)
1             'OUTER_GRID_RUNUP
300.0         'MAX_WAVE_HEIGHT
90            'GRIDC_Timestep (sec)
30000         'NUM_GRIDC_Timesteps
9             'GRIDA_Timestep_MULTIPLE
3            'GRIDB_Timestep_MULTIPLE
180          'OUTPUT_FREQUENCY
```



```
0          'OUTPUT_START
1          'NODE_OUTPUT_FREQ
yakutat_2m_m.asc.s      'GRIDA_DATA
yakutat_24s_m.asc.s    'GRIDB_DATA
yakutat_4s_m.asc.s.s   'GRIDC_DATA
./            'PROP_INPUT_DIR
./            'OUTPUT_DIR
```

Output is written to **output_Yakutat.lis** which contains a runtime stamping, the echoing of initialization, a record of each reading of the input provided by the Propagation Phase, a record of the initial detection of the Propagation Phase wave input, and output events.

```
5-08-2006 18:14:20.000
Site: Yakutat
Input prefix: 1946-
Input Directory: ./
Read Computational parameters: ./most3_facts_nc.in
Minimum amplitude of input offshore wave (m): 0.001
Input minimum depth for offshore (m): 5.
Input "dry land" depth for inundation (m): 0.1
Input friction coefficient (n**2): 0.0009
Input runup switch (0 - runup only in gridC, 1 - runup in all grids): 1
Max allowed eta (m): 30.
Input time step (sec): 1.
Input amount of steps: 30000
Compute "A" arrays every n-th time step, n= 9
Compute "B" arrays every n-th time step, n= 3
Input number of steps between snapshots (should be a multiple of A,B
and C time steps) : 180
...Starting from: 0
...Saving grid every n-th node, n= 1
Reading Bathymetry
1-ST LEVEL:
Bathymetry: ./yakutat_2m_m.asc.s.sm
2-ND LEVEL:
Bathymetry: ./yakutat_18s_m.asc.s.c.s
3-RD LEVEL:
Bathymetry: ./yakutat_4s_m.asc.s.s
DODS URL: ./
Input FACTS files:
zonal U: ./1946-sources-u.nc
meridional V: ./1946-sources-v.nc
amplitudes H: ./1946-sources-h.nc
size of input array: 20 44 1441
Longitude: 217.883367 to 222.950033
Latitude: 56.04742 to 61.93744
Time: 0. to 86400.
NetCDF array size for grid C: 181 55
NetCDF array size for grid B: 201 201
NetCDF array size for grid A: 65 68
output directory: ./
netCDF output: ./Yakutat_runupC_ha.nc
```



```
netCDF output: ./Yakutat_runupC_ua.nc
netCDF output: ./Yakutat_runupC_va.nc
netCDF output: ./Yakutat_runupB_ha.nc
netCDF output: ./Yakutat_runupB_ua.nc
netCDF output: ./Yakutat_runupB_va.nc
netCDF output: ./Yakutat_runupA_ha.nc
netCDF output: ./Yakutat_runupA_ua.nc
netCDF output: ./Yakutat_runupA_va.nc
netCDF initialization complete
input 2 is read at t= 60.
input 3 is read at t= 120.
input 4 is read at t= 180.
.
.
input 99 is read at t= 5880.
input 100 wave detected at 5940. amp: -0.12025176cm at 219.2167 ,
58.07674
Initial surface is read at t= 5940.
input 101 is read at t= 6000.
.
.
output time step 1 6120.sec
Max/Min elevation values in grid C are: 3.59379193E-11/ -4.28528324E-11
Max/Min elevation values in grid B are: 1.87157639E-07/ -6.17153546E-08
Max/Min elevation values in grid A are: 1.24824416E-05/ -0.00246789331
input 104 is read at t= 6180.
.
.
output time step 166 35820.sec
Max/Min elevation values in grid C are: 0.491220241/ -0.283894777
Max/Min elevation values in grid B are: 0.0816834152/ -0.129327379
Max/Min elevation values in grid A are: 0.116327298/ -0.068029162
input 599 is read at t= 35880.
input 600 is read at t= 35940.
Run finished

5-08-2006 18:24:55.000
elapsed secs: 634.429993, user: 633.440002, sys: 0.99000001
clock sec: 635, minutes: 10.583333
```

inundation Data Inputs

The **inundation** requires six input files. Three of the files must be the DEM data that defines the set of three nested input grids.



GRID A DEM DATA FILE	
	File specified by the GRIDA_DATA command input and containing bathy/topo DEM data for the largest and coarsest grid, Grid A, in the MOST DEM file format. Topographical information is optional and is used only if run-up is enabled in Grid A. For more information, see DEM Data File Format .
GRID B DEM DATA FILE	
	File specified by the GRIDB_DATA command input and containing DEM bathy/topo data for the intermediate grid, Grid B, in the MOST DEM file format. Topographical information is optional and is used only if run-up is enabled in Grid B. For more information, see DEM Data File Format .
GRID C DEM DATA FILE	
	File specified by the GRIDC_DATA command input and containing DEM bathy/topo data for the smallest and most detailed grid, Grid C, in the MOST DEM file format. For more information, see DEM Data File Format .

The remaining three input files are the output of **propagation** netCDF, renamed to match **inundation** conventions, each containing one of the three components of a time-stepped Propagation Phase solution: wave height, zonal velocity, and meridional velocity. The directory containing these files is defined by the PROP_INPUT_DIR value specified by **most3_facts_nc.in**. The base name for these files is specified by the **<INPUT_DATAFILE_BASENAME>** command line argument to **inundation**.

Note that the **inundation** executable requires the inputs from the Propagation Phase to have **h.nc**, **v.nc**, or **u.nc** appended to the base name, rather than the **_ha.nc**, **_va.nc**, or **_ua.nc** convention that is output from **propagation**.

The input files are:

PROP_INPUT_DIR /<INPUT_DATAFILE_BASENAME>h.nc	
	A file in netCDF format containing wave height of the tsunami during Propagation Phase simulation. Wave height is measured along the perpendicular away from the center of the Earth and as positive above mean sea level. The output name of the file is PROP_INPUT_DIR/<INPUT_DATAFILE_BASENAME> with the string "h.nc" appended. For more information, see Wave Height File Format .
PROP_INPUT_DIR /<INPUT_DATAFILE_BASENAME>v.nc	
	A file in netCDF format containing the meridional velocity of the tsunami during the Propagation Phase simulation. The meridional velocity is measured parallel to lines of constant longitude and is positive in the North direction. The output name of the file is PROP_INPUT_DIR/<INPUT_DATAFILE_BASENAME> with the string "v.nc" appended. For more information, see Meridional Velocity File Format .



PROP_INPUT_DIR /<INPUT_DATAFILE_BASENAME>u.nc	
	A file in netCDF format containing the zonal velocity of the tsunami during the Propagation Phase simulation. The zonal velocity is measured parallel to lines of constant latitude and is positive in the East direction. The output name of the file is PROP_INPUT_DIR /<INPUT_DATAFILE_BASENAME> with the string "u.nc" appended. For more information, see Zonal Velocity File Format .

inundation Data Outputs

The **inundation** phase saves its solution in netCDF-compliant files located in the directory specified by the value of OUTPUT_DIR in **most3_facts_nc.in**. The number of computational nodes selected for output is determined by the value of NODE_OUTPUT_FREQ set in **most3_facts_nc.in**.

Three sets of data are written to disk, one for each of the computational grids used by **inundation**—Grid A, Grid B, and Grid C. Each set consists of three files, containing the three components of the time-stepped wave equation's solution—wave height, zonal velocity, and meridional velocity. The name of each of the nine files is determined by the following:

- The file's base name is specified by the **<OUTPUT_PREFIX>** command line argument to **inundation**.
- A tag indicates if the source grid is Grid A, Grid B, or Grid C by appending the string "**_runup**" and either "**A**", "**B**" or "**C**".
- A final suffix, indicating the wave solution component saved, is appended to the base name of each component's file. The string "**_ha**" is appended to the file containing wave height information; "**_va**" is appended to the file containing meridional velocity information; and "**_ua**" is appended to the file containing zonal velocity data.
- All data output files for **inundation** have the file extension ".nc".

The Grid A output files are:

OUTPUT_DIR/<OUTPUT_PREFIX>_runupA_ha.nc	
	OUTPUT_DIR/<OUTPUT_PREFIX>_runupA_ha.nc is a netCDF-formatted file containing the wave_height component of the tsunami simulation for every NODE_OUTPUT_FREQ th computational node in Grid A. The data is first saved at time step OUTPUT_START and then at every OUTPUT_FREQUENCY time step thereafter. Wave height is measured along the perpendicular away from the center of the Earth and as positive above mean sea level. For more information, see Wave Height File Format .

OUTPUT_DIR/<OUTPUT_PREFIX>_runupA_va.nc	
	OUTPUT_DIR/<OUTPUT_PREFIX>_runupA_va.nc is a netCDF-formatted file containing the meridional velocity component of the tsunami at simulations for every NODE_OUTPUT_FREQ th computational node in Grid A. The data is first saved at time step OUTPUT_START and then at every OUTPUT_FREQUENCY time step thereafter. The meridional velocity is measured parallel to the longitude and is positive in the North direction. For more information, see Meridional Velocity File Format .



OUTPUT_DIR/<OUTPUT_PREFIX>_runupA_ua.nc	
	OUTPUT_DIR/<OUTPUT_PREFIX>_runupA_ua.nc is a netCDF-formatted file containing the zonal velocity component of the tsunami at simulations for every NODE_OUTPUT_FREQ th computational node in Grid A. The data is first saved at time step OUTPUT_START and then at every OUTPUT_FREQUENCY time step thereafter. The zonal velocity is measured parallel to the latitude and is positive in the East direction. For more information about the format of this file, see Zonal Velocity File Format .

The Grid B output files are:

OUTPUT_DIR/<OUTPUT_PREFIX>_runupB_ha.nc	
	OUTPUT_DIR/<OUTPUT_PREFIX>_runupB_ha.nc is a netCDF-formatted file containing the wave_height component of the tsunami simulation for every NODE_OUTPUT_FREQ th computational node in Grid B. The data is first saved at time step OUTPUT_START and then at every OUTPUT_FREQUENCY time step thereafter. Wave height is measured along the perpendicular away from the center of the Earth and as positive above mean sea level. For more information, see Wave Height File Format .

OUTPUT_DIR/<OUTPUT_PREFIX>_runupB_va.nc	
	OUTPUT_DIR/<OUTPUT_PREFIX>_runupB_va.nc is a netCDF-formatted file containing the meridional velocity component of the tsunami at simulations for every NODE_OUTPUT_FREQ th computational node in Grid B. The data is first saved at time step OUTPUT_START and then at every OUTPUT_FREQUENCY time step thereafter. The meridional velocity is measured parallel to the longitude and is positive in the North direction. For more information, see Meridional Velocity File Format .

OUTPUT_DIR/<OUTPUT_PREFIX>_runupB_ua.nc	
	OUTPUT_DIR/<OUTPUT_PREFIX>_runupB_ua.nc is a netCDF-formatted file containing the zonal velocity component of the tsunami at simulations for every NODE_OUTPUT_FREQ th computational node in Grid B. The data is first saved at time step OUTPUT_START and then at every OUTPUT_FREQUENCY time step thereafter. The zonal velocity is measured parallel to the latitude and is positive in the East direction. For more information, see Zonal Velocity File Format .



The Grid C output files are:

OUTPUT_DIR/<OUTPUT_PREFIX>_runupC_ha.nc	
	OUTPUT_DIR/<OUTPUT_PREFIX>_runupC_ha.nc is a netCDF-formatted file containing the wave_height component of the tsunami simulation for every NODE_OUTPUT_FREQ th computational node in Grid C. The data is first saved at time step OUTPUT_START and then at every OUTPUT_FREQUENCY time step thereafter. Wave height is measured along the perpendicular away from the center of the Earth and as positive above the mean sea level. For more information, see Wave Height File Format .
OUTPUT_DIR/<OUTPUT_PREFIX>_runupC_va.nc	
	OUTPUT_DIR/<OUTPUT_PREFIX>_runupC_va.nc is a netCDF-formatted file containing the Meridional velocity component of the tsunami at simulations for every NODE_OUTPUT_FREQ th computational node in Grid C. The data is first saved at time step OUTPUT_START and then at every OUTPUT_FREQUENCY time step thereafter. The Meridional velocity measured parallel to the longitude and is positive in the North direction. For more information, see Meridional Velocity File Format .
OUTPUT_DIR/<OUTPUT_PREFIX>_runupC_ua.nc	
	OUTPUT_DIR/<OUTPUT_PREFIX>_runupC_ua.nc is a netCDF-formatted file containing the zonal velocity component of the tsunami at simulations for every NODE_OUTPUT_FREQ th computational node in Grid C. The data is first saved at time step OUTPUT_START and then at every OUTPUT_FREQUENCY time step thereafter. The zonal velocity is measured parallel to the latitude and is positive in the East direction. For more information about the format of this file, see Zonal Velocity File Format .

bath_sample

The **bath_sample** tool extracts subsections from a DEM data file. Both input and output are in the DEM data file format.

bath_sample Restrictions

The **bath_sample** tool is restricted to bathymetric grids less than or equal to 10800 nodes of latitude (North/South) by 10800 nodes of longitude (East/West).

bath_sample Command Inputs

The **bath_sample** tool obtains command inputs from *stdin*.

Standard Input

The **bath_sample** command inputs obtained from *stdin* can be provided interactively or by input redirection. A typical input file redirected into *stdin* might look like the following:

```
indo_lrg.corr ' BATHYMETRIC_FILE, output will be filename.s
2            ' X_SAMPLE every n-th node X (E-W) axis
12          ' X_START Starting node on X (E-W) axis
5399        ' X_STOP Stopping node on X (E-W) axis
```



```

6           ' Y_SAMPLE every n-th node on Y (N-S) axis
2000       ' Y_START Starting node on Y (N-S) axis
2715       ' Y_STOP Stopping node on Y (N-S) axis

```

Note that an input file passed to *stdin* for **bath_sample** should have no tabs, only spaces.

BATHYMETRIC_FILE		
A string containing the path to the input DEM data file to be sampled.		
	FORMAT	CHARACTER*80
	USAGE	Maximum Length: 80 Characters The prefix may be relative or absolute, but must not contain environment variables or wildcard/globbing patterns such as: ". ./", ". /", or "~ /". Data output is written to BATHYMETRIC_FILE.s.

X_SAMPLE		
The stride between nodes extracted from the input DEM data file along the X (East–West) axis.		
	FORMAT	INTEGER
	USAGE	Minimum Value: 1 Maximum Value: Maximum extent in X (East–West) of input data set The bath_sample executable extracts every X_SAMPLE th node along the X (East–West) axis of the input data set, and writes it to the output DEM file.

X_START		
The first node to be extracted from the input DEM data file along the X (East–West) axis.		
	FORMAT	INTEGER
	USAGE	Minimum Value: 1 Maximum Value: Maximum extent in X (East–West) of input data set. The extraction X_SAMPLE th node along the X (East–West) axis of the input DEM input file begins with node X_START.

X_STOP		
The last node to be extracted from the input DEM data file along the X (East–West) axis.		
	FORMAT	INTEGER



	USAGE	Minimum Value: X_START + 1 Maximum Value: Maximum extent in X (East–West) of input data set The extraction X_SAMPLE th node along the X (East–West) axis of the input DEM input file ends with the node X_STOP.
--	--------------	--

Y_SAMPLE		
The stride between nodes extracted from the input DEM data file along the Y (North–South) axis.		
	FORMAT	INTEGER
	USAGE	Minimum Value: 1 Maximum Value: Maximum extent in Y (North–South) of input data set The bath_sample executable extracts every Y_SAMPLE th node along the Y (North–South) axis of the input data set, and writes it to the output DEM file.

Y_START		
The first node extracted from the input DEM data file along the Y (North–South) axis.		
	FORMAT	INTEGER
	USAGE	Minimum Value: 1 Maximum Value: Maximum extent in Y (North–South) of input data set The extraction Y_SAMPLE th node along the Y (North–South) axis of the input DEM input file begins with node Y_START.

Y_STOP		
The last node extracted from the input DEM data file along the Y (North–South) axis.		
	FORMAT	INTEGER
	USAGE	Minimum Value: Y_START + 1 Maximum Value: Maximum extent in Y (North–South) of input data set The extraction Y_SAMPLE th node along the Y (North–South) axis of the input DEM input file ends with the node Y_STOP.

bath_sample Command Outputs

The **bath_sample** executable writes command output to *stdout*. Below is sample output, from the redirected input shown above.

```
./bath_sample <bath_sample.in
```



```
Reading Bathymetry
  Bathymetry filename:  Grid dimensions in X,Y: 1275 949
Geographic area (E-W):   35.017 -- 119.950
Geographic area (S-N):  -34.982 --  24.985
ALONG X:
Saving grid every n-th node, n=
... starting from:
12 35.75degr E
... until:
5399 0.degr E
ALONG Y:
Saving grid every n-th node, n=
... starting from:
2000 0.degr N
... until:
2715 0.degr N
Writing surface into file
indo_lrg.corr.s
New dimensions: 2694 120
```

bath_sample Data Inputs

One data input file is required by **bath_sample**.

BATHYMETRIC_FILE	
	File specified by the BATHYMETRIC_FILE command input and containing DEM data in the MOST DEM file format. DEM input files for bath_sample are currently limited to grids of no more than 10800 nodes of latitude (North/South) by 10800 nodes of longitude (East/West). For more information, see DEM Data File Format .

bath_sample Data Outputs

One data output file is produced by **bath_sample**. The output file name is BATHYMETRIC_FILE.s.

BATHYMETRIC_FILE.s	
	File named BATHYMETRIC_FILE.s contains a selected subset of the input file DEM BATHYMETRIC_FILE, written in MOST DEM file format. For more information, see DEM Data File Format .

bath_corr

For a given input DEM data set, **bath_corr** performs the following:

1. Attempts to correct problematic features in DEM input file by smoothing unphysical rates of change (steepness) in ocean floor depth, and altering structures, such as islands, that are resolved only to a single node.
2. Returns the maximum time-step size for wave propagation modeling compliant with the Courant, Friedrichs, and Lewy stability condition for the modified DEM data set.



Corrected DEM data is written to a file named **Bat.corrected**. As **bath_corr** reads and overwrites the **Bat.corrected** file, it is good practice to copy DEM data to that file and use it as both input and output. This allows the program to be run iteratively over the same DEM data until no significant modifications are found in the program's command output. For more information about correcting bathymetric data, see [Bathymetric Correction Tools](#).

bath_corr Restrictions

The **bath_corr** tool is restricted to bathymetric grids less than or equal to 4500 nodes of latitude (North/South) by 4500 nodes of longitude (East/West).

bath_corr Command Input

The **bath_corr** command inputs obtained from *stdin* can be provided interactively or by input redirection.

Standard Input

A typical input file redirected into *stdin* might look like the following:

```
10          'MAX_WAVE_HEIGHT (m)
10          'MIN_DEPTH_THRESH (m)
1          'STEEPNESS_THRESHOLD
Bat.corr   'BATHYMETRIC_FILE
```

Note that an input file passed to *stdin* for **bath_corr** should have no tabs, only spaces.

MAX_WAVE_HEIGHT		
Maximum wave height expected in a Propagation Phase or Inundation Phase calculation.		
	FORMAT	REAL*8
	USAGE	<p>Measured in meters.</p> <p>Typical Value: 0 meters</p> <p>The bath_corr uses the total water depth to calculate its steepness corrections for tsunami propagation. The value of MAX_WAVE_HEIGHT is added to the total local water depth at a given node for increased accuracy. In general, in deep water MAX_WAVE_HEIGHT is much smaller than the total water depth, and this correction has little effect, but can be significant in shallower depths. If an estimate of the maximum wave height is not available, this parameter can be set to zero (0).</p>

MIN_DEPTH_THRESH		
Specifies the minimum depth of DEM data to be corrected.		
	FORMAT	REAL*8



	USAGE	<p>Measured in meters.</p> <p>Typical Value: 0 meters</p> <p>The bath_corr tool does not attempt to correct DEM data whose depth is less than or equal to MIN_DEPTH_THRESH. Zero (0) values of MIN_DEPTH_THRESH will apply correction to the shoreline.</p>
--	--------------	--

STEEPNESS_THRESHOLD		
Specifies the maximum steepness—rate of change in ocean floor depth—allowed in DEM data being processed by bath_corr .		
	FORMAT	REAL*8
	USAGE	<p>Minimum Value: 0.0</p> <p>Maximum Value: 1.0</p> <p>Typical Value: 0.5</p> <p>Defines the minimum steepness value to trigger correction from bath_corr.</p>

BATHYMETRIC_FILE		
A string containing the file name of a DEM input file to be corrected.		
	FORMAT	CHARACTER*80
	USAGE	<p>Maximum Length: 80 Characters</p> <p>The prefix may be relative or absolute, but must not contain environment variables or wildcard/globbing patterns such as: <code>"../"</code>, <code>"./"</code>, or <code>"~/</code>".</p>

bath_corr Command Outputs

The **bath_corr** tool writes command output to *stdout*. In addition, the old and new value of each grid node being corrected and a corrected DEM data file are written to **Bat.corrected**.

Below is a sample output from the redirected input shown above. The output contains a list of all corrections that were made to the input DEM data set, and as a final output, the maximum time-step size compliant with the CFL wave propagation modeling condition for the corrected data set (in **bold**).

```

./bath_corr <bath_corr.in
' Max wave height estimate:
Minimum depth in computation:
Steepness threshold:
Reading Bathymetry
Bathymetry filename: Corrections along X
1 point: i,j= 113 1824
Original : 378. 19.5 11.
Corrected: 378. 107.7512 11.

```



```
2 point: i,j= 124 1781
Original : 329.73 19.5 11.
Corrected: 329.73 81.2710559 11.
3 point: i,j= 140 462
Original : 476. 19.5 -54.
Corrected: 476. 173.7248 -54.
.
.
.
207 point: i,j= 2537 870
Original : 11. 19.5 375.
Corrected: 11. 105.9968 375.
208 point: i,j= 2549 1298
Original : 590. 19.5 9.
Corrected: 590. 269.12 9.
Writing surface into file Bat.corrected
Maximum dt= 11.7971563
at depth 6777.m; i,j= 2026 5
```

bath_corr Data Inputs

One data input file is required by **bath_corr**.

BATHYMETRIC_FILE	
	File specified by the BATHYMETRIC_FILE command input, and containing the DEM data, in the MOST DEM file format, which needs to be corrected. DEM input files for bath_corr are currently limited to grids of no more than 4500 nodes of latitude (North/South) by 4500 nodes of longitude (East/West). For more information, see DEM Data File Format .

bath_corr Data Outputs

One data output file is produced by **Bat.corrected**.

BATHYMETRIC_FILE.s	
	The file Bat.corrected contains corrected DEM data in MOST DEM format. The file can be used both as input and output. For more information, see DEM Data File Format .



Data File Formats

MOST calculations use five distinct data file formats. Two of the data file formats—the DEM data file format and the deformation output file format—are text file formats. The remaining three file formats are tsunami wave solution file formats—wave height file format, meridional velocity file format, and zonal velocity file format. These file formats store the time-stepped output of the propagation equations for the tsunami simulation and are [netCDF](#) files.

DEM Data File Format

A DEM data-formatted file contains ocean sounding, shoreline depth, and topographical elevation information for a grid of latitude and longitudes. The DEM data file format is a text file, written with a FORTRAN format of "FORMATTED." Depth values are positive numbers, measured from mean high water. Areas above sea level are represented by negative.

The DEM data file format consists of four parts:

- **Grid Size**

The first line of a DEM data-formatted file, consisting of two INTEGER values separated by a space or comma. These two values specify the number of longitude (NUM_LON) and latitude nodes (NUM_LAT) in the DEM data set:

```
1275 949
```

- **Longitude Node List**

A vector of NUM_LOG longitude values, one per line, specified using decimal degrees in either the 360° or ±180° reference system. The spacing between longitude nodes does not have to be uniform, although uniformity is recommended.

```
35.01667000000000  
35.08334000000000  
35.15000000000000  
35.21667000000000  
.  
.  
.  
119.81670000000000  
119.88330000000000  
119.95000000000000
```

- **Latitude Node List**

A vector of NUM_LAT latitude values, one per line, specified using decimal degrees. The spacing between latitude nodes does not have to be uniform, For datasets covering a large geographic extent, such as the propagation grids, the spacing may be adjusted to ensure that the grid cells have roughly consistent shape throughout the dataset. This would require a closer grid cell spacing near the poles than at the equator.

```
24.98493000000000  
24.92450000000000  
24.86402000000000  
24.80352000000000
```



```
.  
. .  
. .  
-34.8731400000000  
-34.9278200000000  
-34.9824600000000
```

- **DEM Data**

A matrix of ocean depth/topographical elevation values, one for each latitude/longitude pair. The matrix consists of NUM_LAT lines, each containing NUM_LON floating point depth or elevation values, measured in meters, separated by spaces. Positive values indicate depth below mean sea level; negative values indicate elevation.

```
3.00 284.00 500.00 598.00 . . .  
4.00 86.00 364.00 514.00 . . .  
4.00 3.00 114.00 284.00 . . .  
. . .  
2840.00 2814.00 2954.00 2952.00 . . .  
2888.00 2822.00 2880.00 2853.00 . . .  
2875.00 2815.00 2956.00 2920.00 . . .
```

Below is a set of declarations and a FORTRAN fragment designed to read a DEM data-formatted file.

```
real*8 d(m,n),q(m,n)  
real*8 h1(n1),h2(n2)  
character*80 fname  
. . .  
open(unit=1,file=fname),status='old'  
  
&      ,form='formatted')  
read (1,5) n1,n2  
read (1,10) (h1(i), i=1,n1)  
read (1,10) (h2(i), i=n2,1,-1)  
do j=n2,1,-1  
    read (1,100) (d(i,j), i=1,n1)  
end do  
5    format(I6,I6)  
10   format(F20.13)  
100  format (4500F10.2)  
  
close(unit=1,status='keep')
```



Deformation Output File Format

The deformation output file format stores changes in ocean surface height at a selected sub-grid of DEM data. The deformation output file format is a text file, written with a FORTRAN format of "FORMATTED."

The deformation output file format consists of two parts:

- **Deformation Area Information**

The first line of a deformation output format file consisting of six (6) values, separated by a space or comma: two (2) INTEGER values, followed by two (2) REAL*4 values, followed by two (2) more INTEGER values.

```
150 150 287.2735 -35.69531 4235 1632
```

The first two values indicate the size, in nodes of latitude (NUM_LAT) and then nodes of longitude (NUM_LON), of the subsection of the input DEM data grid modified by the seismic effects generated from the deformation rectangle input to a Deformation Phase calculation.

The second two values are the latitude (RECT_LAT) and longitude (RECT_LON) of the location reference of the input deformation rectangle.

The final two values are the origin for the region of the DEM input data modified. The origin of the region is its Northwest corner, expressed in nodes of latitude (X_ORIG) and longitude (Y_ORIG).

The example shows Deformation Phase data from a deformation rectangular area whose Northwest corner is located at latitude 287.2735°, and 35.69531° lon., applied to a sub-grid of the original DEM input whose Northwest corner is found at the node coordinate (4235, 1632), with a size of 150 by 150 nodes.

- **Ocean Surface Deformation**

Information about surface deformation to be applied to the sub-grid located at (X_ORIG, Y_ORIG) of size NUM_LAT by NUM_LON. Changes in ocean surface height are shown as positive definite from mean sea level downward (toward the Earth's center). Surface height deviations above mean sea level (away from the Earth's center) are specified in negative values.

Data is held as REAL*8 values and is written out as NUM_LON records of length NUM_LAT in exponential format.

```
9.64361382E-05 9.56628765E-05 9.48007085E-05 9.38457548E-05
9.27937942E-05 9.1640798E-05 9.03825621E-05 8.90145545E-05
8.75324629E-05
8.59321038E-05 8.42084808E-05 8.23572492E-05 8.03742856E-05
7.82542221E-05 7.59927634E-05 7.35856783E-05 7.10277253E-05
6.83147379E-05 6.54425602E-05 6.24061645E-05 5.92016385E-05
5.58254148E-05 5.22724621E-05 4.85395599E-05 4.46238383E-05
4.05206706E-05 3.62278586E-05 3.17434298E-05 2.7063528E-05
2.21872745E-05
1.71137036E-05 1.18403433E-05 6.36753919E-06 6.96366936E-07
```



Below is a set of declarations and a FORTRAN fragment designed to read a deformation output file.

```
integer m,n,id,jd,nd1,nd2,i,j
parameter (m=2581)
parameter (n=2063)
real*8 d(m,n),iq(m,n)
real*4 xlon,xlat
.
.
.
open(unit=1,file=fname),status='old
&      ,form='formatted')

read (1,*) nd1,nd2,xlon,xlat,id,jd
do j=1,nd2
  read (1,*) (iq(i,j),i=1,nd1)
end do
close(unit=1,status='keep')
```

Wave Evolution File Formats

The MOST wave evolution file formats contain time-stepped data about one of the following modeled tsunami wave's characteristic components:

- Wave height in centimeters
- Meridional velocity in centimeters/second
- Zonal velocity in centimeters/second

The files are saved in [netCDF V 3.6.1](#) format, and therefore the structure of each type of wave evolution file format is uniquely described using the [network Common Data form Language](#) (CDL). For more information on netCDF, see <http://www.unidata.ucar.edu/software/netcdf/>.

Wave Height File Format

A wave height formatted file contains:

- The file base name and other comments.
- The size of the DEM grid as measured in nodes of longitude and latitude.
- The approximate source of the longitude and latitude seismic event that generated the tsunami, expressed as REAL*4 values.
- The time step, latitude, and longitude expressed as REAL*8 values, and wave height (measured in centimeters) expressed as a REAL*4 value, for each node saved in the propagation simulation.

Below is an example [CDL](#) for a wave height formatted file, with a base name of `indo2min_ha`, for a grid of 1276 longitude by 950 latitude nodes.

```
netcdf indo2min_ha {
dimensions:
  LON = 1276 ;
  LAT = 950 ;
  TIME = UNLIMITED ; // (3 currently)
```



```
variables:
  double LON(LON) ;
    LON:units = "degrees_east" ;
    LON:point_spacing = "even" ;
  double LAT(LAT) ;
    LAT:units = "degrees_north" ;
    LAT:point_spacing = "uneven" ;
  float SLON ;
    SLON:units = "degrees_east" ;
    SLON:long_name = "Source Longitude" ;
  float SLAT ;
    SLAT:units = "degrees_north" ;
    SLAT:long_name = "Source Latitude" ;
  double TIME(TIME) ;
    TIME:units = "SECONDS" ;
  float HA(TIME, LAT, LON) ;
    HA:units = "CENTIMETERS" ;
    HA:long_name = "Wave Amplitude" ;
    HA:missing_value = -1.e+34f ;
    HA:_FillValue = -1.e+34f ;
    HA:history = "From surf_ reverse." ;

  // global attributes:
    :history = "FERRET V4.91 (GUI) 3-Dec-98" ;
}
```

Below is a set of declarations and a FORTRAN fragment using the netCDF libraries designed to read the wave heights (the netCDF variable ID: HA_ID) from a wave height formatted file for a given time step (T_stp).

```
C netCDF id
  integer*4  NCID

C variable ids
  integer*4  HA_ID
  integer*4  T_stp

  include 'netcdf.inc'
C error status return
  integer*4  iret

C netCDF dimension sizes for dimensions used with record variables
  integer*4  LON_len
  integer*4  LAT_len

C rank (number of dimensions) for each variable
  integer*4  VAR_rank
  parameter (VAR_rank = 3)

C starts and counts for array sections of record variables
  integer*4  VAR_start(VAR_rank), VAR_count(VAR_rank)
```



```
data VAR_start /1, 1, 1/
```

C data variables

```
integer*4  VAR_nr
parameter (VAR_nr = 1)
real*4  VAR(LON_len, LAT_len, VAR_nr)
real*8  vr01(mm0,nn0)

integer iret
character *80 fname

iret = nf_open(fname,0,NCID)
call check_err(iret)
iret = nf_inq(NCID,ndims,HA_ID,ngatts,ncunl_id)

VAR_count(1) = LON_len
VAR_count(2) = LAT_len
VAR_count(3) = 1

VAR_start(3) = T_stp
VAR_count(3) = VAR_nr
iret = nf_get_vara_real(ncid,HA_ID,VAR_start,VAR_count,VAR)
do i=1,LON_len
do j=1,LAT_len
vr01(i,j) = VAR(i,j,1)
end do
end do
end
```

Meridional Velocity File Format

A meridional velocity formatted file contains:

- The file base name and other comments.
- The size of the DEM grid as measured in nodes of longitude and latitude.
- The approximate source of the longitude and latitude seismic event that generated the tsunami, expressed as REAL*4 values.
- The time step, latitude, and longitude expressed as REAL*8 values, and v-wave velocity (measured in centimeters per second) expressed as a REAL*4 value, for each node saved in the propagation simulation.

Below is an example [CDL](#) for a meridional velocity formatted file, with a base name of **indo2min_va**, for a grid of 1276 longitude by 950 latitude nodes.

```
netcdf indo2min_va {
dimensions:
  LON = 1276 ;
  LAT = 950 ;
  TIME = UNLIMITED ; // (3 currently)
```



```
variables:
  double LON(LON) ;
    LON:units = "degrees_east" ;
    LON:point_spacing = "even" ;
  double LAT(LAT) ;
    LAT:units = "degrees_north" ;
    LAT:point_spacing = "uneven" ;
  float SLON ;
    SLON:units = "degrees_east" ;
    SLON:long_name = "Source Longitude" ;
  float SLAT ;
    SLAT:units = "degrees_north" ;
    SLAT:long_name = "Source Latitude" ;
  double TIME(TIME) ;
    TIME:units = "SECONDS" ;
  float VA(TIME, LAT, LON) ;
    VA:long_name = "Velocity Component along Latitude" ;
    VA:units = "CENTIMETERS/SECOND" ;
    VA:missing_value = -1.e+34f ;
    VA:_FillValue = -1.e+34f ;
    VA:history = "From surf_ reverse." ;

  // global attributes:
    :history = "FERRET V4.91 (GUI) 3-Dec-98" ;
}
```

Below is a set of declarations and a FORTRAN fragment using the netCDF libraries designed to read the meridional velocity (the netCDF variable ID: VA_id) from a wave height formatted file for a given time step (T_stp).

```
C netCDF id
  integer*4  NCID

C variable ids
  integer*4  VA_id
  integer*4  T_stp

  include 'netcdf.inc'

C error status return
  integer*4  iret

C netCDF dimension sizes for dimensions used with record variables
  integer*4  LON_len
  integer*4  LAT_len

C rank (number of dimensions) for each variable
  integer*4  VAR_rank
  parameter (VAR_rank = 3)

C starts and counts for array sections of record variables
```



```
integer*4 VAR_start(VAR_rank), VAR_count(VAR_rank)
data VAR_start /1, 1, 1/
```

C data variables

```
integer*4 VAR_nr
parameter (VAR_nr = 1)
real*4 VAR(LON_len, LAT_len, VAR_nr)
real*8 vr01(mm0,nn0)

integer iret
character *80 fname

iret = nf_open(fname,0,NCID)
call check_err(iret)
iret = nf_inq(NCID,ndims,VA_id,ngatts,ncunl_id)

VAR_count(1) = LON_len
VAR_count(2) = LAT_len
VAR_count(3) = 1

VAR_start(3) = T_stp
VAR_count(3) = VAR_nr
iret = nf_get_vara_real(ncid,VA_id,VAR_start,VAR_count,VAR)
do i=1,LON_len
  do j=1,LAT_len
    vr01(i,j) = VAR(i,j,1)
  end do
end do
end
```

Zonal Velocity File Format

A zonal velocity formatted file contains:

- The file base name and other comments.
- The size of the [DEM](#) grid as measured in nodes of longitude and latitude.
- The approximate source of the longitude and latitude seismic event that generated the tsunami, expressed as REAL*4 values.
- The time step, latitude, and longitude expressed as REAL*8 values, and zonal velocity (measured in centimeters per second) expressed as a REAL*4 value, for each node saved in the propagation simulation.

Below is an example CDL for a zonal velocity formatted file, with a base name of **indo2min_ua**, for a grid of 1276 longitude by 950 latitude nodes.

```
netcdf indo2min_ua {
dimensions:
  LON = 1276 ;
  LAT = 950 ;
```



```
        TIME = UNLIMITED ; // (3 currently)
variables:
  double LON(LON) ;
        LON:units = "degrees_east" ;
        LON:point_spacing = "even" ;
  double LAT(LAT) ;
        LAT:units = "degrees_north" ;
        LAT:point_spacing = "uneven" ;
  float SLON ;
        SLON:units = "degrees_east" ;
        SLON:long_name = "Source Longitude" ;
  float SLAT ;
        SLAT:units = "degrees_north" ;
        SLAT:long_name = "Source Latitude" ;
  double TIME(TIME) ;
        TIME:units = "SECONDS" ;
  float UA(TIME, LAT, LON) ;
        UA:long_name = "Velocity Component along Longitude" ;
        UA:units = "CENTIMETERS/SECOND" ;
        UA:missing_value = -1.e+34f ;
        UA:_FillValue = -1.e+34f ;
        UA:history = "From surf_  reverse." ;

// global attributes:
        :history = "FERRET V4.91 (GUI) 3-Dec-98" ;
}
```

Below is a set of declarations and a FORTRAN fragment using the netCDF libraries designed to read the zonal velocity (the netCDF variable ID: UA_ID) from a wave height formatted file for a given time step (T_stp).

```
C netCDF id
      integer*4  NCID

C variable ids
      integer*4  UA_ID
      integer*4  T_stp

      include 'netcdf.inc'
C error status return
      integer*4  iret

C netCDF dimension sizes for dimensions used with record variables
      integer*4  LON_len
      integer*4  LAT_len

C rank (number of dimensions) for each variable
      integer*4  VAR_rank
      parameter (VAR_rank = 3)

C starts and counts for array sections of record variables
```



```
integer*4 VAR_start(VAR_rank), VAR_count(VAR_rank)
data VAR_start /1, 1, 1/
```

C data variables

```
integer*4 VAR_nr
parameter (VAR_nr = 1)
real*4 VAR(LON_len, LAT_len, VAR_nr)
real*8 vr01(mm0,nn0)

integer iret
character *80 fname

iret = nf_open(fname,0,NCID)
call check_err(iret)
iret = nf_inq(NCID,ndims,UA_ID,ngatts,ncunl_id)

VAR_count(1) = LON_len
VAR_count(2) = LAT_len
VAR_count(3) = 1

VAR_start(3) = T_stp
VAR_count(3) = VAR_nr
iret = nf_get_vara_real(ncid,UA_ID,VAR_start,VAR_count,VAR)
do i=1,LON_len
  do j=1,LAT_len
    vr01(i,j) = VAR(i,j,1)
  end do
end do
end
```



Appendix I: Performance Issues

This appendix discusses the performance expectations for each MOST phase.

Propagation Phase Performance

The **propagation** time-to-completion depends primarily on the size of the DEM input data set, the size and number of time steps in the simulation, and the frequency with which its state is saved. The dependence of the time-to-completion on state saving depends on the I/O configuration of the system on which **propagation** is run. In general, the dependence should be roughly **linear** with regard to both the frequency of saving state, and grid size (defined as the number of x nodes \times the number of y nodes). The dependence on number of time steps is **linear**. The computational dependency of DEM input data set size scales **linearly** in x and y and **linearly** in the product $x \cdot y$.

For a typical MOST installation using Red Hat Enterprise Linux v 4.2, a Portland Group (V 6.1) compiler, on at least an Intel Xeon 2.6 GHz or equivalent processor with a processor cache 2 MB and 5 GB of memory, a Propagation Phase simulation using DEM with dimensions of (2581, 2063), with 5760 time steps, saving the state every 4 time step, can expect the time-to-completion to be 8 hours.

Inundation Phase Performance

The **inundation** time-to-completion depends on the update time of each of the three grids (Grid A, Grid B, Grid C) used in the calculation. The Grid C contribution to performance depends on the size (in nodes) of its DEM grids, the size and number of time steps in the simulation, and the frequency at which a state is saved. As Grid A and Grid B are not updated at every time step, their contribution depends primarily on grid size (in nodes), the frequency at which each grid is updated, and the frequency at which a state is saved.

The dependence of the time-to-completion on state saving depends on the I/O configuration of the system on which **inundation** is run. In general, the I/O performance dependence of the contribution due to any one grid should be roughly **linear** with regard to both the frequency of saving state and grid size (defined as the number of x nodes \times the number of y nodes). The contribution by each grid to time-to-completion due to the computational dependency on the size of its DEM input data set size scales **linearly** in x and y and **linearly** in the product $x \cdot y$. Dependence on the number of Grid C time steps is roughly **linear**, as is the Grid B and Grid C calculation's dependence of the frequency of update for the outer grids.

For a typical MOST installation using Red Hat Enterprise Linux v 4.2, a Portland Group (V 6.1) compiler, on at least an Intel Xeon 2.6 GHz or equivalent processor, with a processor cache 2 MB and 5 GB of memory, a simulation where Grid A, Grid B, and Grid C have DEM grid dimensions of (196, 161), (119, 150), and (125, 170) respectively, running for 10000 Grid C time step, updating Grid B every 1th Grid C time step, updating Grid A every 10th Grid C time step, and saving state every 20th Grid C time step for every node, the time-to-completion can be expected to be on the order of 7 minutes. (Note that depending on the application the values provided above may or may not be typical).



Appendix II: Troubleshooting

Deformation Phase Simulations

Deformation Phase calculations of ocean displacement are particularly sensitive to the [slip magnitude](#) and [strike angle](#) inputs. As the output sub-grid targeted by **deform** should contain the bulk of surface disruption due to a given deformation rectangle input, the correctness of a Deformation Phase run can be checked by:

- Ensuring that the location of the output sub-grid chosen by **deform** is approximately centered over the deformation rectangle.
- Verifying that the data in **deform.dat** shows only minor displacements along the edges of the [DEM](#) output sub-grid.

As overlap is permitted for output sub-grids used as input to the Propagation Phase, choosing a large output sub-grid—even one covering the entire area of a fault rupture straddling multiple deformation rectangles—may be good practice.

Troubleshooting Bathymetric Smoothing

The **bath_corr** tool is designed to smooth out unphysical bathymetric features from an input DEM. (For more information on using **bath_corr**, see [Input Correction Tools](#) and [bath_corr](#).) Typically, **bath_corr** is applied iteratively, with the output of one pass using **bath_corr** being used as input to the next.

Iterating on a bathymetric data set is considered terminated if the output file does not get updated between iterations, or if a minimum the number of corrections is found for a given iteration—that is, the number of modified nodes reported ceases to drop and starts to go up. If changes appear to be small and are 'oscillating' between iterations, it may be reasonable to assume that **bath_corr** has arrived at a reasonable DEM configuration. This configuration can be used 'as-is', or the **bath_corr** parameters (particularly the steepness threshold) can be tightened to see if it further resolves any issues.

It is also important to determine if unstable regions correspond to known bathymetric features, deep water features (deeper than 5000 m) or possible artifacts generated in the creation of the bathymetric data set for MOST (such as joining to subsidiary data sets). It may be necessary to obtain new data, or to manually adjust the bathymetric data using an editor or a tool such as **Ferret** or **MATLAB**. It is left to expertise of the user to determine the effect of manual corrections on the solution.

In manipulating **bath_corr** parameters, remember that:

- Decreasing the value of steepness means that smaller changes in elevation are included in the **bath_corr** calculation, which may provide enough input for the iterative calculation to converge. This manipulation will also likely increase the time-to-completion of a **bath_corr** run.
- Increasing the values make the program more tolerant of small variations in bathymetry which may allow the program to ignore small features that are not relevant to Propagation Phase and Inundation Phase calculations.

Check with the MOST user community to see if others have encountered this problem.



In addition to a failure of iterative smoothing to converge, problems in bathymetric smoothing are found in the appearance of unphysical behavior in the wave propagation calculations of the Propagation Phase or Inundation Phase calculations. These problems are discussed below.

Troubleshooting Tsunami Wave Evolution Programs

Propagation Phase and Inundation Phase calculations are both based on the same [NSW](#) wave model to calculate wave propagation and are vulnerable to similar sets of instability issues and problems. The most common problems are due to steep gradients on the sea floor and single-node artifacts (such as small islands). Steep gradients in the sea floor in the wave path will degrade the performance and the accuracy of the NSW algorithms used by **propagation** and **inundation** by introducing numerical errors.

Oftentimes, the gradients are not associated with relevant bathymetric features, having only a very limited, local effect on the overall propagation of the wave. However, the numerical cost of calculating propagation over such features could become expensive. MOST accumulates numerical error when the wave encounters this type of feature, resulting in the development of two possible situations:

1. In the worst-case scenario, the accumulation of error renders the calculation locally unstable, with the instability propagating away from the original location and eventually contaminating the entire solution. The code will not be able to converge onto an accurate solution.
2. Local instabilities develop, but they have a limited impact on the overall solution. The instabilities remain confined to a small region of the computational domain and do not contaminate the solution outside of that area. The solution in regions away from the origin of the instability is likely to be reliable, even though an assessment of the degree of contamination of the solution should be made.

MOST has difficulty calculating the wave behavior when a single node lies above sea level—the problem here arises in both spatial directions. A similar situation arises when a line of nodes above sea level appears in the bathymetry files. In this case the problem is restricted to one spatial direction, but both situations can potentially degenerate into a propagating instability. This type of instability is easily identified by the appearance of spurious high-frequency waves originating in a localized area including only one or two grid nodes that are said to be “ringing.” In practice, whether the island is represented by a single node or a small cluster of them has negligible effect on wave propagation, and these types of structures should be corrected by adding “dry” (above sea level) nodes until no single or line node islands are present.

In most cases, the presence of these undesired structures is eliminated automatically when the bathymetry correction tool, *bath_corr.f* is run. If the problem persists, using increasingly smaller values of the “steepness threshold” with the bathymetry correction tool may solve it. However, there are instances in which single-node islands and more often node line islands persist after the use of *bath_corr.f*. In these cases, if the structures are observed to be the cause of developing instabilities, they should be eliminated manually by opening the bathymetry file in a text editor, locating the destabilizing nodes, and adding nodes appropriately to avoid single dry nodes. Some software packages like MATLAB can be extremely more helpful than a simple text editor in manually modifying the data.



Appendix III: Acronyms

CDL	network COMMON DATA form LANGUAGE
DEM	Digital Elevation Model
FACTS	Facility for the Analysis and Comparison of Tsunami Simulations For more information, see http://sift.pmel.noaa.gov/FACTS/main.pl
GEBCO	General Bathymetric Chart of the Oceans
GIS	Geographic Information System
MOST	Method of Splitting Tsunami
NAD83	North American Datum for 1983
NETCDF	network Common Data Form For more information, see http://my.unidata.ucar.edu/content/software/netcdf/index.html .
NGDC	National Geophysical Data Center of the National Oceanic and Atmospheric Administration (NOAA) For more information, see http://www.ngdc.noaa.gov/ .
NOAA	The National Oceanic and Atmospheric Administration For more information, see http://www.noaa.gov/ .
NSW	Nonlinear Shallow Water (NSW) wave equations
PMEL	Pacific Marine Environmental Laboratory of the National Oceanic and Atmospheric Administration
SIFT	Short-Term Inundation Forecasting for Tsunamis For more information, see http://sift.pmel.noaa.gov/SIFT/main.pl
USACE	United States Army Corps of Engineers
USGS	United States Geological Survey
USNGIA	U.S. National Geospatial-Intelligence Agency



Appendix XIII: Glossary

BATHYMETRY

The oceanic component of a Digital Elevation Model, providing the measurements of the depth of the ocean floor relative to a [vertical datum](#) on a well-defined horizontal (x,y) grid system; undersea equivalent of topography.

In MOST documentation, unless specifically noted, bathymetric and topographical data are assumed to be part of a unified DEM, with positive values referring to ocean depth and negative values referring to dry land elevation.

DATUM

A set of parameters and control points, relative to a three-dimensional shape of the Earth, defining a planar coordinate system by which [geodetic](#) data are measured.

A datum is defined in terms of an initial point on a [reference ellipsoid](#) model of the Earth's surface.

DEFORMATION RECTANGLE

A region used for the MOST Deformation Phase input to model a section of the ocean floor along a ruptured fault that is disturbed by a seismic event.

DIGITAL ELEVATION MODEL

A geographic data set containing a regularly-spaced horizontal (x,y) grid, measured relative to a specific [horizontal datum](#), with elevation or depth (z) data relative to a [vertical datum](#).

DIP ANGLE

The angle measured downward between a horizontal plane representing the local Earth surface and the local fault plane.

FAULT PLANE

A plane that represents the surface of a ruptured fault.

FAULT LINE

See Fault Trace.

FAULT TRACE

The line marking the intersection of the fault plane with a horizontal plane representing the local Earth surface. Also referred to as a fault line.

FOOT WALL

The lower interface of an incline.

GENERAL BATHYMETRIC CHART OF THE OCEANS

A publicly-available bathymetry data set for the world's oceans provided by the Marine Geology and Geophysics Division of the National Geophysical Data Center (NGDC) for the National Oceanic and Atmospheric Administration (NOAA).

For more information, see <http://www.ngdc.noaa.gov/mgg/gebco/>.



GEODETTIC

The horizontal and vertical location of a point on the Earth, defined relative to a [reference ellipsoid](#).

GEOGRAPHIC INFORMATION SYSTEM

Software model or tool used to store, analyze, manipulate, and/or display forms of geographically-referenced information.

GRID A

The outermost finite difference grid used in Inundation Phase calculations.

This finite difference grid defines the boundaries of an Inundation Phase calculation and has the largest geographic extent, the coarsest grid resolution, and the largest time step.

GRID B

The middle finite difference grid of DEM data used in Inundation Phase calculations.

The values of the geographic extent, resolution, and time step of this finite difference grid lie between those of Grid A and Grid C.

GRID C

The innermost finite difference grid of DEM data used in Inundation Phase calculations.

This finite difference grid defines the boundaries of an Inundation Phase calculation and has the smallest geographic extent, the finest grid resolution, and the smallest time step.

HANGING WALL

The upper border of an inclined fault.

For more information, see [Seismic Inputs](#).

HORIZONTAL DATUM

The specific reference parameters and control points for data in the horizontal (x, y) plane of a geographic coordinate system.

EPICENTER

The place of origin of a seismic event commonly specified by a latitude, longitude, and depth beneath sea level.

MERIDIONAL VELOCITY

The North/South component of velocity, tangent to the surface of the Earth and parallel to lines of constant longitude. Often referred to as the vertical velocity component, and typically represented by v or v_a in equations of motion.

NETWORK COMMON DATA FORM

A machine-independent format and programming interface used to represent array-oriented scientific data. Also known as [netCDF](#).

For more, see <http://my.unidata.ucar.edu/content/software/netcdf/index.html>.



network COMMON DATA form LANGUAGE

A text representation and scripting language used to describe the layout of a [netCDF](#) data set. Also referred to as [CDL](#).

RAKE ANGLE

The angle between the direction of slip along the fault and a horizontal plane representing the local Earth. Also known as the [slip angle](#).

For more information, see [Seismic Inputs](#).

REFERENCE ELLIPSOID

A mathematically-defined surface approximating the true figure of the Earth or geoid, providing the reference system which is used to define elevation (vertical datum) and location (horizontal datum).

RUN DOWN

The retreat from maximum inundation of a tsunami striking a shoreline region.

RUN-UP

The progress to maximum shoreline inundation of a tsunami.

SHORELINE

The origin or "zero" value relative to a [vertical datum](#) used to represent [bathymetry](#) or [topography](#) in a [Digital Elevation Model](#); the points where water meets land.

SLIP ANGLE

The angle between the direction of slip along the fault and a horizontal plane representing the local Earth. Also known as the [rake angle](#).

For more information, see [Seismic Inputs](#).

SLIP MAGNITUDE

The magnitude in meters of the displacement along a fault during a seismic event.

For more information, see [Seismic Inputs](#).

SLIP MAGNITUDE SCALING

A factor applied during Propagation Phase calculations to scale the [slip magnitude](#) of the Deformation Phase outputs that are used as **propagation.exe** inputs.

SPATIAL RESOLUTION

The minimum difference between two geographic features. Generally, spatial resolution refers to the horizontal (x , y) difference between two features. Vertical spatial resolution is used to describe the vertical (z) difference between two features.

STRIKE ANGLE

The angle in a clockwise direction between the local fault trace and geographic North.

For more information, see [Seismic Inputs](#).



THROW

The magnitude of vertical displacement between the opposing sides of a fault caused by the seismic event.

For more information, see [Seismic Inputs](#).

TOPOGRAPHY

The dry-land elevation component of a Digital Elevation Model, providing the measurements of the elevation of dry land relative to a [vertical datum](#) on a well-defined x,y coordinate system; the dry land equivalent of bathymetry.

In MOST documentation, unless specifically noted, bathymetric and topographical data are assumed to be part of a unified Digital Elevation Model, with positive values referring to ocean depth and negative values referring to dry land elevation.

VERTICAL DATUM

The specific reference parameters and control points for vertical (z) data in a geographic coordinate system.

ZONAL VELOCITY

The East/West component of velocity, tangent to the surface of the Earth and parallel to lines of constant latitude. Often referred to as the horizontal velocity component, and typically represented by u or u_a in equations of motion.



Appendix V: Units

ARCMINUTE

A unit of angular measure in a geographic coordinate system.

One arcminute is:

- 1/60 of a degree.
- Approximately 1800 meters.

ARCSECOND

A unit of angular measure in a geographic coordinate system, often used in the geographic community when describing subsets of horizontal spacing on a geographic coordinate system

One arcsecond is:

- 1/60th of an arcminute, which is 1/60 of a degree.
- Approximately 30 meters.



Appendix VI: Numerical Methods

Most Numerical Model Background

Titov, V., and Gonzalez, F. I., (1997): Implementation and testing of the Method of Splitting Tsunami (MOST) model. NOAA Tech. memo. ERL PMEL-112, (PB98-122773), NOAA/Pacific Marine Environmental Laboratory, Seattle, WA.

Titov, V.V. and Synolakis, C. E., (1995): Modeling of Breaking and Nonbreaking Wave Evolution and Runup using VTCS-2, *Journal of Waterways, Ports and Coastal Engineering*, Vol. 121, 6, pp. 308-316.

Courant, Friedrichs, and Lewy (CFL) Stability Condition

Courant, Friedrichs, and Lewy,

which requires:

$$\Delta t < c \Delta x$$

where Δt is the size of the time step, Δx is the grid spacing, and c is the characteristic speed of wave propagation. The value of c is typically on the order of \sqrt{gH} , where: g is the acceleration of gravity, 9.8 m/s and H is the local water depth in meters.



Appendix VII: Data Resources

Seismic Information Data Resources

<http://earthquake.usgs.gov/>

Digital Elevation Model Data Resources

ETOPO2

Global relief database for both ocean and land areas (combined bathymetry and topography) with two (2) arcminute (3600 m) resolution provided by [NGDC](#).

For more information, see <http://www.ngdc.noaa.gov/mgg/global/global.html> and <http://www.ngdc.noaa.gov/mgg/fliers/01mgg04.html>.

ETOPO5

Global relief database for both ocean and land areas (combined bathymetry and topography) with five (5) arcminute (9000 m) resolution provided by NGDC. This data has been superseded by ETOPO2.

For more information, see <http://www.ngdc.noaa.gov/mgg/global/global.html> and <http://www.ngdc.noaa.gov/mgg/fliers/93mgg01.html>.

GLOBE

A quality-controlled global Digital Elevation Model (DEM) with a thirty (30) arcsecond (1000 m) gridding and resolution provided by NGDC.

For more information, see <http://www.ngdc.noaa.gov/mgg/global/global.html> and <http://www.ngdc.noaa.gov/mgg/topo/globe.html>.

NATIONAL GEOGRAPHIC DATA CENTER (NGDC)

The Division of Marine Geology and Geophysics and the World Data Center for Marine Geology & Geophysics, Boulder, that compiles, maintains, archives, and distributes data from extensive databases in both coastal and open ocean areas.

For more information, see <http://www.ngdc.noaa.gov/mgg/aboutmgg/aboutmgg.html> and <http://www.ngdc.noaa.gov/mgg/aboutmgg/aboutwdcmgg.html>.

NORTH AMERICAN DATUM FOR 1983 (NAD83)

The [datum](#) for map projections and coordinates within the United States and throughout North America drawn up in 1983.

TERRAINBASE

Global relief database for both ocean and land areas (combined bathymetry and topography) with five (5) arcminute (9000 m) resolution provided by NGDC. This data has been superseded by ETOPO2.

For more information, see <http://www.ngdc.noaa.gov/seg/fliers/se-1104.shtml>.



Appendix VIII: Recommended Software

Visualization and Data Management Software

FERRET

Ferret is an interactive computer visualization and analysis environment designed to meet the needs of oceanographers and meteorologists analyzing large and complex gridded data sets. **Ferret** can be used to examine the evolution of a tsunami, complete with background maps, and to examine and modify DEM and wave propagation outputs. Ferret is free and available for download.

For more information, see <http://ferret.wrc.noaa.gov/Ferret/>.

MATLAB

The **MATLAB**[®] application provides a high-level programming language, an interactive technical computing environment, and functions for algorithm development, data analysis and visualization, and numeric computation. The **MATLAB** application can be used to examine the evolution of a tsunami, complete with background maps, and to examine and modify DEM and wave propagation outputs. The application must be purchased from The MathWorks.

For more information, see <http://www.mathworks.com>.

GIS Software

GENERIC MAPPING TOOLS (GMT)

GMT is an open source collection of tools for manipulating geographic and Cartesian data sets and producing reports and illustrations. The tool can be used to map data across different values of vertical or horizontal datum. **GMT** is supported by the [National Science Foundation](#), released under the [GNU General Public License](#), and is free and available for download.

For more information, see <http://www.soest.hawaii.edu/GMT/>

NATIONAL GEODETIC SURVEY GEODETIC TOOL KIT

[NGS Geodetic Toolkit](#) is free and available for download.

For more information, see <http://www.ngs.noaa.gov/TOOLS/>.

NOAA VDATUM TRANSFORMATION TOOL

VDatum is designed to transform coastal elevations between the datum defining 28 different vertical reference systems for tidal, orthometric, and ellipsoidal (three-dimensional) information. **VDatum** is free and available for download.

For more information, see <http://chartmaker.ncd.noaa.gov/csdl/vdatum.htm>.

ESRI ARCGIS[®] 9

Licensed by ESRI, inc.

For more information, see <http://www.esri.com/>.



References

- Mofjeld, H.O., A.J. Venturato, F.I. González, V.V. Titov, and J.C. Newman (2004): *The Harmonic Constant Datum Method: Options For Overcoming Datum Discontinuities at Mixed-Diurnal Tidal Transitions*. J. Atmos. Ocean. Tech., 21, 95–104.
- Titov, V.V., González, F.I, and Newman, J. C. (1990), *Offshore Forecasting of Alaska-Aleutian Subduction Zone Tsunamis in Hawaii*. NOAA Tech Memo ERL PMEL-144, NOAA/Pacific Marine Environmental Laboratory, Seattle, WA.
- Venturato, A.J. (2004): A Digital Elevation Model For Seaside, Oregon: Procedures, Data Sources, and Analyses. NOAA Tech. Memo. OAR PMEL-127, 17
- Venturato, A.J. (2005): NOAA TIME Eastern Strait Of Juan De Fuca, Washington, Mapping Project: Procedures, Data Sources, and Products. NOAA Tech. Memo. OAR PMEL-129



Index

A	
arcminute, defined	94
arcsecond, defined	94
B	
Bat.corrected file	15
bath_corr	15–17, 71–74
bath_sample	14–15, 68–71
bathymetric data, modifying	13
bathymetric gradients, correcting for	15
C	
CFL condition	See Courant, Friedrichs, and Lewy stability condition
configuration, recommended Linux	2
constructing DEM data sets	7
correcting steep bathymetric gradients	15
Courant, Friedrichs, and Lewy stability condition ...	15, 35, 95
D	
data compatibility	8
data resources	96
deform	18–22, 41–47
configuring	19
DEM inputs	18
outputs	21
processing deformation rectangle	13
seismic inputs	18
stdin	18
troubleshooting	22
deformation output file format	77
Deformation Phase	1, 18–22
deformation rectangles	12, 13, 18
DEM	1
constructing	7
data compatibility	8
file format	75
grid requirements	6
input data	5–10
parameters	7
sources	7
Digital Elevation Models	See DEM
dip	10
E	
epicenter	10
ETOPO2	7, 96
ETOPO5	96
F	
Facility for the Analysis and Comparison of Tsunami Simulations (FACTS)	13
fastest-wave velocity	15
fault plane	10
Ferret	30, 87, 97
file formats	
deformation output	77
DEM data	75
wave evolution	
meridional velocity	80
wave height	78
zonal velocity	82
finite difference grid	5, 18, 30
foot wall	12
G	
grids	
minimum requirements	5
used in inundation phase	30
H	
hanging wall	12
horizontal datum	7
I	
inundation	29–40, 53–68
configuring	32
DEM inputs	30
grids	30
input naming conventions	31
log files	40
outputs	39
propagation inputs	30
required boundary condition parameters	32
Inundation Phase	1, 29–40



L		
Linux recommended configuration.....	2	
M		
Manning coefficient of friction.....	33, 36, 58	
MATLAB	30, 87, 88, 97	
meridional velocity		
file format	80	
propagation output file	29	
Method of Splitting Tsunami.....	See MOST	
MOST		
bald earth approximation	36	
DEM grid requirements.....	6	
file formats		
deformation output	77	
DEM data	75	
wave evolution	78	
meridional velocity	80	
wave height	78	
zonal velocity	82	
input		
DEM	5–10	
seismic.....	10–13	
installation kit	3	
installing	3	
introduction	1	
minimum grid requirements	5	
negative grid values	5	
performance issues	85	
positive grid values	5	
requesting	2	
troubleshooting.....	87	
N		
National Oceanic and Atmospheric Administration.....	1	
netCDF.....	2, 3, 29, 39, 50, 75, 89	
NOAA	1	
Nonlinear Shallow Water wave equations....	22, 47, 88	
non-uniform input gridding	10	
P		
Pacific Marine Environmental Laboratory.....	1	
performance issues.....	85	
PMEL.....	1	
propagation	22–29, 47–53	
configuring.....	24–27	
DEM inputs	23	
ocean displacement inputs.....	23	
outputs	29	
stdin	23	
Propagation Phase	1, 22–29	
R		
rake	10	
requirements, minimum grid	5	
resources for obtaining data	96	
run-up calculations	6	
S		
seismic input, obtaining	10–13	
Short-Term Inundation Forecasting for Tsunamis (SIFT)	13	
single-node features, correcting for	15	
slip	10	
slip magnitude.....	10	
spatial resolution recommendations.....	6	
strike.....	10	
system configuration, recommended	2	
T		
Titov	18	
topographical data requirements	6	
trace	10	
troubleshooting.....	87	
tsunami modeling	18–40	
U		
UNIX, installing MOST software on	3	
V		
Venturato	7	
vertical datum	7	
W		
wave evolution file formats.....	41–84	
meridional velocity	80	
wave height	78	
zonal velocity	82	



MOST Software Manual

wave height
file format 78
propagation output file..... 29

Z

zonal velocity
file format 82
propagation output file..... 29